

QUESTION 1: MULTIPLE-CHOICE QUESTIONS

- 1.1 B ✓ (1)
- 1.2 C ✓ (1)
- 1.3 D ✓ (1)
- 1.4 C ✓ (1)
- 1.5 A ✓ (1)
- 1.6 A or C ✓ (1)
- 1.7 D ✓ (1)
- 1.8 A ✓ (1)
- 1.9 B ✓ (1)
- 1.10 C ✓ (1)
- 1.11 D ✓ (1)
- 1.12 B ✓ (1)
- 1.13 B ✓ (1)
- 1.14 A ✓ (1)
- 1.15 D ✓ (1)
- 1.16 A ✓ (1)
- 1.17 B ✓ (1)
- 1.18 D ✓ (1)
- 1.19 C ✓ (1)
- 1.20 B ✓ (1)
- [20]**

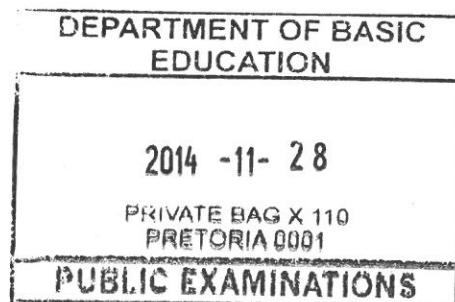

QUESTION 2: SAFETY**2.1 Gas cylinders:**

- Store full cylinders apart from empty cylinders. ✓
- Keep in cool place and protect them from sunlight and other sources of heat. ✓
- Always store and use gas cylinders in an upright position. ✓
- Store different gas cylinders separately. ✓
- Never stack cylinders on top of one another. ✓
- Do not bang or work on the cylinders. ✓
- Never allow cylinders to fall. ✓
- No oil and grease should come into contact with gas cylinders or fittings. ✓
- Keep the caps on the cylinders for protection. ✓
- Do not store near flammable materials. ✓
- Store in a well ventilated area. ✓
- Ensure the correct assembly of regulators ✓
- Close valves ✓

(Any 3x1) (3)**2.2 Arc welding:**To protect your skin and eyes against the dangerous ultra-violet rays. ✓ **(1)****2.3 Safety before using a machine:**

- Always clamp work pieces and holding devices properly. ✓
- Know where the ON/OFF switch is located. ✓
- Make sure that all guards are in place. ✓
- Make sure that there is no oil or grease on the floor around the machine. ✓
- Wear all necessary safety equipment. ✓
- Do not use machine without proper training. ✓
- Do not use machine without permission. ✓
- Make sure that the machine is in working order. ✓

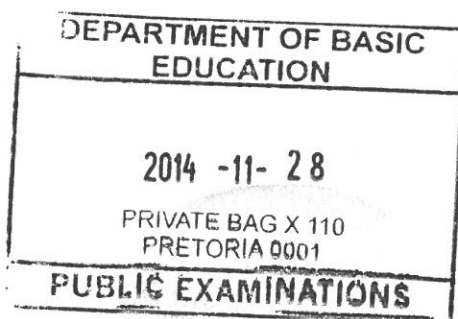
(Any 2x1) (2)**2.4 Safety after using a machine:**Switch the machine off. ✓ **(1)****2.5 Bench grinder:**The maximum is a 3 mm gap. ✓ **(1)****2.6 Gas analyser:**To ensure a more accurate reading or no readings at all. ✓ ✓ **(2)****[10]**

QUESTION 3: TOOLS AND EQUIPMENT**3.1 Causes of low compression:**

- Worn cylinders ✓
- Worn inlet valves ✓
- Worn outlet valves ✓
- Worn compression rings ✓
- Worn piston ✓
- Worn head gasket ✓
- Leaking, cracked, wrong settings of valves and cylinder head ✓

(Any 2 x 1) (2)**3.2. MIGS/ MAGS:****3.2.1 MIGS/ MAGS: PURPOSE OF INERT GAS**

- Stabilises the arc on the parent metal ✓
- Shields the arc and weld pool from atmospheric gases like oxygen ✓

(2)**3.2.2 Advantages of MIGS/ MAGS:**

- Can weld in any position ✓
- Less operator skill required ✓
- Long welds can be made without stops and starts ✓
- Causes less deformation ✓
- Faster than arc welding ✓
- Minimal post weld cleaning ✓
- No slag removal is required ✓
- Gives better finish ✓

(2)**3.3 Spring tester:**

- To check for correct tension ✓
- To check for elasticity ✓
- Check according to manufacturer's specification ✓

(2)**3.4 Multimeter:**

- A. LCD display screen/Reading screen ✓
- B. Range selector switch ✓
- C. 10A DC socket ✓
- D. VΩmA socket ✓

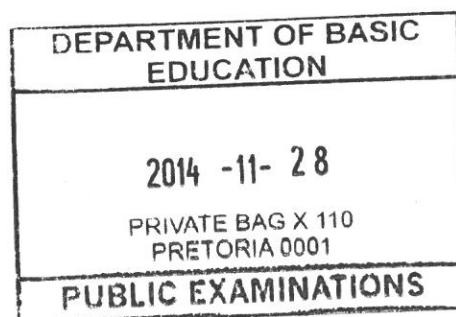
(4)**[12]**

QUESTION 4: MATERIALS**4.1 Iron-carbon diagram:****4.1.1 Labelling:**

- A. Ferrite + Pearlite ✓
- B. Pearlite + Cementite ✓
- C. Ferrite + Austenite ✓
- D. Cementite + Austenite ✓
- E. Austenite ✓

(5)

4.1.2 AC₁

- It represents the lowest temperature ✓ to which steel must be heated to be hardened. ✓
- It is the temperature ✓ where the first change in structure ✓ takes place.

(Any 1 x 2)

(2)

4.2 Characteristics of:**4.2.1 Cementite:**

- Intensely hard ✓
- Brittle ✓

(2)

4.2.2 Ferrite:

- Soft ✓
- Ductile / malleable ✓

(2)

4.3 Austenite:

Austenite is a combination ✓ of iron and carbon which is called iron carbide. ✓

(2)

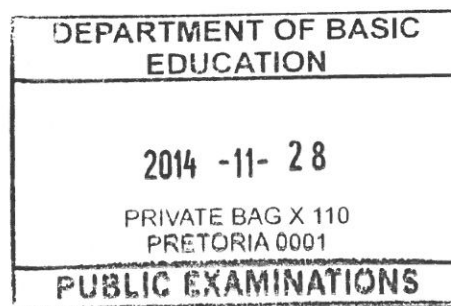
[13]

QUESTION 5: TERMINOLOGY

5.1 Screw thread terminology:

- A. Crest / Outside / Normal / Major / Full / Basic diameter ✓
- B. Effective / Pitch diameter ✓
- C. Root / Core / Inside / Minor diameter ✓
- D. Angle (60° ✓) / Thread angle
- E. Crest ✓
- F. Root ✓
- G. Flank ✓

(7)

5.2 Milling operations:

Gang milling ✓✓

(2)

5.3 Keyway cutting:

5.3.1 Side and Face cutter ✓

(1)

- 5.3.2 A. Work piece / Shaft ✓
- B. Keyway ✓
- C. Ruler / Scale ✓
- D. Cutter (Side and face) ✓
- E. Square ✓

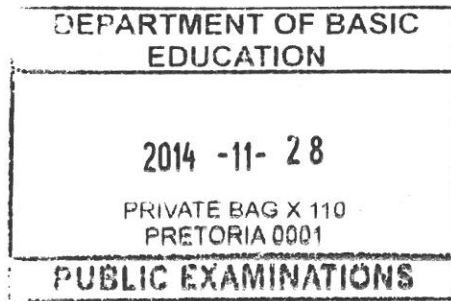

(5)

Key calculations:

Unit need to be specified – if omitted = no mark / Wrong unit = no mark

5.3.3 Width of key = $\frac{\text{Diameter of shaft}}{4}$

$= \frac{48}{4}$ ✓

$= 12 \text{ mm}$ ✓

(2)

5.3.4 Thickness of key = $\frac{\text{Diameter of shaft}}{6}$

$= \frac{48}{6}$ ✓

$= 8 \text{ mm}$ ✓

(2)

5.3.5 Length of key = $1,5 \times \text{Diameter}$

$= 1,5 \times 48$ ✓

$= 72 \text{ mm}$ ✓

(2)

5.3.6 Distance = $\frac{1}{2}$ diameter of shaft – $\frac{1}{2}$ width of cutter

$= 24 - 6$ ✓

$= 18 \text{ mm}$ ✓

(3)

5.4 **Indexing:**

$$\begin{aligned} \text{Indexing} &= \frac{40}{n} && \checkmark \\ &= \frac{40}{14} \\ &= 2 \frac{6 \times 4}{7 \times 4} && \checkmark \\ &= 2 \frac{24}{28} && \checkmark \end{aligned}$$

- 2 full turns of the crank and 24 holes in a 28 hole circle
- 2 full turns of the crank and 36 holes in a 42 hole circle ✓
- 2 full turns of the crank and 42 holes in a 49 hole circle (4)

5.5 **TWO methods for screw cutting:**

Cross slide ✓ and compound slide ✓ (2)
[30]

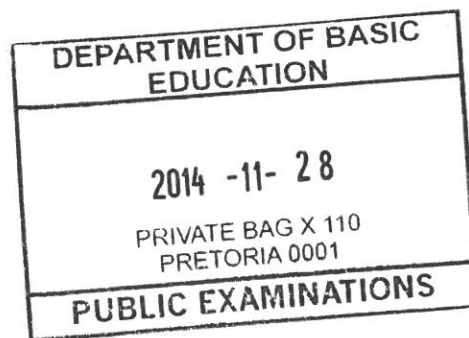

QUESTION 6: JOINING METHODS**6.1 Causes of welding defects:****6.1.1 Porosity:**

- Atmospheric contamination ✓
- Surface contamination / Dirty / Rusted ✓
- Dirty or wet electrodes with arc welding ✓
- Rusted wire with MIGS/MAGS ✓
- Incorrect flame / setting ✓
- Low current ✓

(Any 3x1) (3)**6.1.2 Slag inclusion:**

- Incorrect current settings / Low current setting / Weld temperature is too low ✓
- Included angle too narrow ✓
- Rapid chilling ✓
- High viscosity of molten metal ✓
- The previous weld slag has not been removed ✓

(Any 3x1) (3)**6.2 Nick break test:**

- Each edge of the weld is slotted by means of a saw. ✓
- Place the specimen on two steel supports / In a bench vice. ✓
- Use a hammer to break the specimen by striking it in the zone where the cut was made. ✓
- The weld metal exposed should be completely fused, free from slag inclusions and contain no gas pockets greater than 1,6 mm. ✓
- There should not be more than one pore or gas pocket per square centimetre. ✓

(5)**6.3 Dye penetration test:**

- Clean the weld that needs to be tested. ✓
- Spray dye onto the surface and leave to penetrate. ✓
- Excess dye is cleaned away with a cleaning agent. ✓
- Allow surface to dry. ✓
- Spray a developer onto the surface to bring out the dye trapped in the crack. ✓
- The dye will show all the surface defects. ✓

(5)**6.4 Advantages of non-destructive tests:**

- The test is done without destroying the usefulness of a finished product ✓
- It is the fastest and least expensive in terms of the finished product. ✓

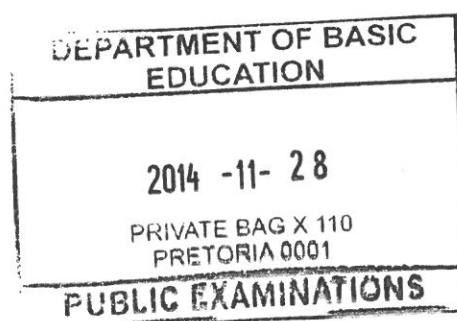
(2)

6.5 **MIGS / MAGS welding process:**

- A. Parent metal ✓
- B. Weld pool ✓
- C. Electrode wire ✓
- D. Gas shroud / Welding pistol ✓
- E. Contact tube / Nozzle ✓
- F. Shielding gas ✓
- G. Earth cable / Clamp / Ground ✓

(7)
[25]

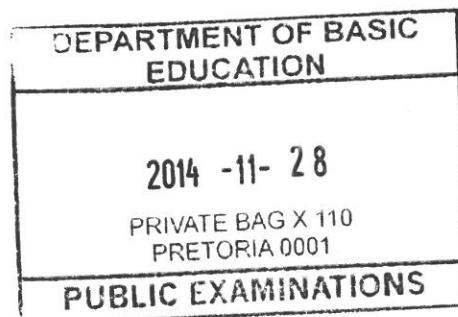

QUESTION 7: FORCES

7.1 Resultant:

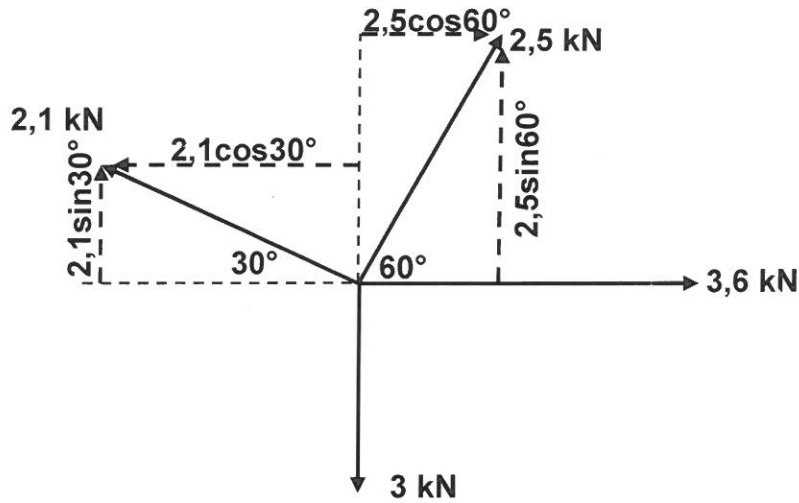

7.1.1 The sum of the horizontal components

$$\begin{aligned} \sum HC &= 3,6 + 2,5\cos60^\circ - 2,1\cos30^\circ && \checkmark\checkmark\checkmark \\ &= 3,6 + 1,25 - 1,82 && \checkmark \\ &= 3,03 \text{ kN} && \checkmark\checkmark \end{aligned}$$

7.1.2 The sum of the vertical components

$$\begin{aligned} \sum VC &= 2,5\sin60^\circ + 2,1\sin30^\circ - 3 && \checkmark\checkmark\checkmark \\ &= 2,17 + 1,05 - 3 && \checkmark \\ &= 0,22 \text{ kN} && \checkmark\checkmark \end{aligned}$$

OR

Horizontal component	Magnitudes	Vertical component	Magnitudes
$2,1 \cos 30^\circ \checkmark$	-1,82 kN	$2,1 \sin 30^\circ \checkmark$	1,05 kN
$2,5 \cos 60^\circ \checkmark$	1,25 kN \checkmark	$2,5 \sin 60^\circ \checkmark$	2,17 kN \checkmark
3,6 kN \checkmark	3,6 kN	-3 kN \checkmark	-3 kN
TOTAL	3,03 kN $\checkmark\checkmark$	TOTAL	0,22 kN $\checkmark\checkmark$

(12)

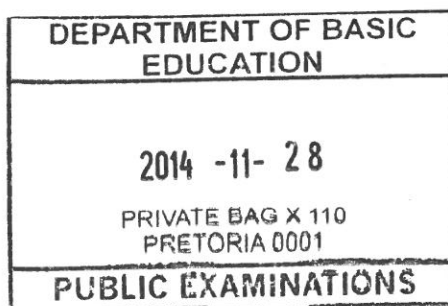

7.2.1 **Stress:**

$$A = \frac{\pi D^2}{4} \quad \checkmark$$

$$A = \frac{\pi(0,05)^2}{4} \quad \checkmark$$

$$A = 1,963495 \times 10^{-3} \text{ m}^2 \quad \checkmark$$

$$\text{Stress} = \frac{\text{Load}}{\text{Area}} \quad \checkmark$$

$$\sigma = \frac{F}{A} \quad \checkmark$$

$$\sigma = \frac{50 \times 10^3}{1,96 \times 10^{-3}} \quad \checkmark$$

$$\sigma = 25,51 \times 10^6 \text{ Pa} \quad \checkmark$$

OR

$$\sigma = 25,51 \text{ MPa}$$

No / wrong unit – no mark

(4)

7.2.2 **Strain:**

$$\text{Strain} = \frac{\text{Change in length}}{\text{Original length}} \quad \checkmark$$

$$\text{Strain} = \frac{0,005}{3} \quad \checkmark$$

$$= 1,6667 \times 10^{-3} \quad \checkmark$$

(3)

7.3 **Stress/ strain diagram**

A = Limit of proportionality ✓

B = Limit of elasticity ✓

C = Yield point ✓

D = Maximum stress ✓

E = Break stress / Break point ✓

(5)

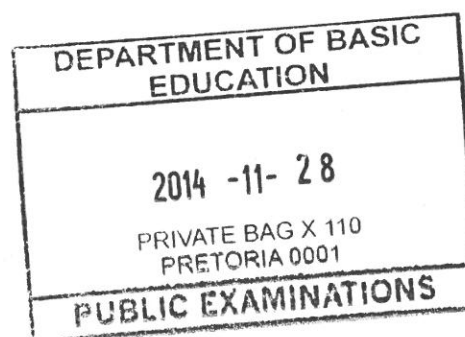

7.4 **Moments:**

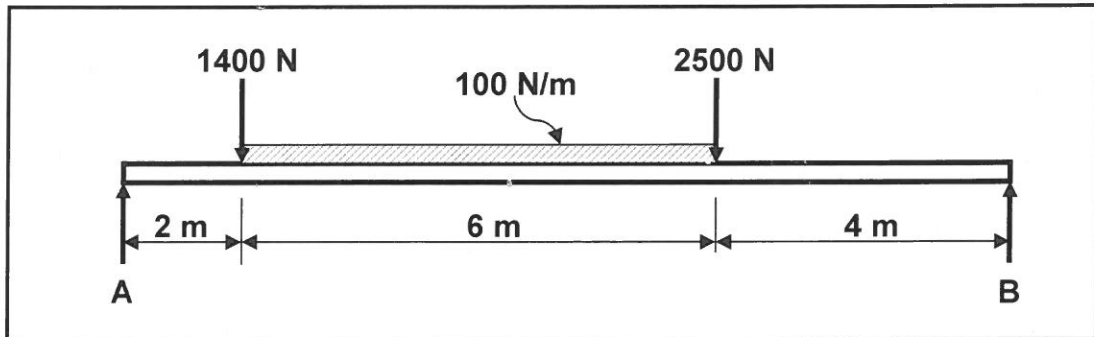

Calculate A
Take moments about B

$$A \times 12 = (2500 \times 4) + (600 \times 7) + (1400 \times 10) \quad \checkmark$$

$$A \times 12 = 10000 + 4200 + 14000 \quad \checkmark$$

$$\frac{12A}{12} = \frac{28200}{12} \quad \checkmark$$

$$A = 2350 \text{ N} \quad \checkmark$$

Calculate B
Take moments about A

$$B \times 12 = (1400 \times 2) + (600 \times 5) + (2500 \times 8) \quad \checkmark$$

$$B \times 12 = 2800 + 3000 + 20000 \quad \checkmark$$

$$\frac{12B}{12} = \frac{25800}{12} \quad \checkmark$$

$$B = 2150 \text{ N}$$

(6)
[30]

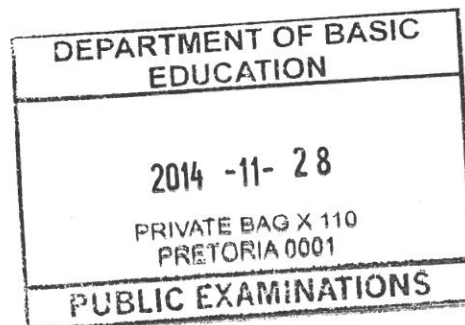

[Handwritten signature]

[Handwritten signature]

QUESTION 8: MAINTENANCE**8.1 EP – oil:**

Manual Gearbox and differential. ✓ (1)

8.2 Abbreviations:

8.2.1 SAE: Society of Automotive Engineers ✓ (1)

8.2.2 ATF: Automatic Transmission Fluid ✓ (1)

8.3 Properties of grease:

- It must be water resistant; it must not mix with water. ✓
 - Prevents rust / corrosion. ✓
 - Good for load pressures. ✓
 - High melting point. ✓
 - Low freezing point. ✓
 - Prevent gumming ✓
 - Be able to lubricate ✓
- (Any 2x1) (2)**

8.4 Maintenance of V belt drives:

- Check the contact surfaces of the pulley to prevent the belt from being damaged. ✓
 - Check the belt condition and replace if it is worn. ✓
 - Correct installation procedure must be followed. ✓
 - Belt drives should be well guarded to prevent foreign objects to come into contact with the belts and pulleys. ✓
 - Keep guard mesh free of papers, rags etc. that can cause insufficient air flow. ✓
 - Check that belt deflection is according to specification. ✓
 - Store replacement belts in a cool, well ventilated place. ✓
 - Correct alignment of pulleys
- (Any 2x1) (2)**

8.5 Causes of clutch slip:

- Worn friction material ✓
 - Oil on friction material ✓
 - Over loading ✓
 - Lack of pressure on friction surfaces ✓
 - Broken clutch plate / pressure plate ✓
 - Incorrect adjustment (free play) ✓
 - Worn flywheel ✓
- (Any 3x1) (3)**

8.6 Clutch replacement:

- Clutch plate ✓
 - Pressure plate / Fly wheel ✓
 - Thrust bearing / Release bearing / pilot bearing ✓
- (Any 3x1) (3)**

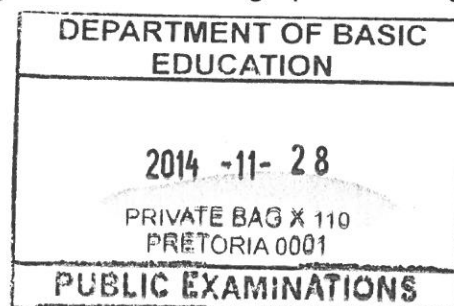

8.7 **Viscosity of engine oil:**

- The oil will not stay between the surfaces in contact, it will just flow through. ✓
- The oil will not have enough time to carry away the heat generated by the friction of the moving parts. ✓

(2)

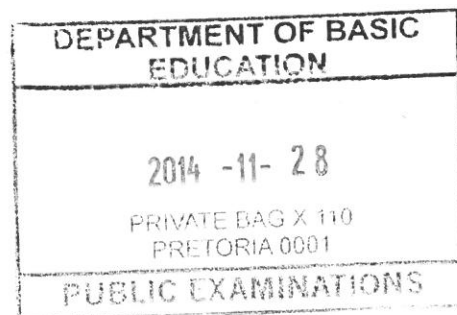

QUESTION 9: SYSTEMS AND CONTROL

9.1 Gear drives:

Rotation frequency of the electric motor:

One mark – magnitude / one mark for the unit

$$\begin{aligned} \frac{N_A}{N_D} &= \frac{T_B \times T_D}{T_A \times T_C} && \checkmark \\ N_A &= \frac{T_B \times T_D}{T_A \times T_C} \times N_D && \checkmark \\ N_A &= \frac{56 \times 76}{40 \times 28} \times 800 && \checkmark \\ &= 3040 \text{ rpm} && \checkmark \checkmark \end{aligned} \tag{5}$$

9.2 Belt Drives:

9.2.1 Diameter of the driven pulley:

$$\begin{aligned} N_{DN} \times D_{DN} &= N_{DR} \times D_{DR} && \checkmark \\ D_{DN} &= \frac{N_{DR} \times D_{DR}}{N_{DN}} && \checkmark \\ D_{DN} &= \frac{1440 \times 0,16}{3840} && \\ D_{DN} &= 0,06 \text{ m} && \checkmark \\ &= 60 \text{ mm} && \end{aligned} \tag{3}$$

9.2.2 Power transmitted:

$$\begin{aligned} \frac{T_1}{T_2} &= 2,5 && \checkmark \\ T_2 &= \frac{320}{2,5} && \checkmark \\ T_2 &= 128 \text{ N} && \checkmark \\ P &= \frac{(T_1 - T_2) \pi D n}{60} && \checkmark \\ P &= \frac{(320 - 128) \pi \times 0,16 \times 1440}{60} && \checkmark \\ P &= 2316,23 \text{ Watt} && \checkmark \end{aligned} \tag{4}$$

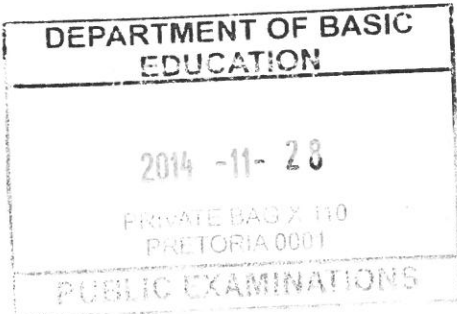

NOTE: If driven diameter and speed is used to calculate power, mark correct, i.e. 2 316,23 Watt.

9.3 **Hydraulics:**9.3.1 **Fluid pressure:**

$$A_B = \frac{\pi D^2}{4}$$

$$A_B = \frac{\pi(0,13)^2}{4}$$

$$A_B = 13,273228 \times 10^{-3} \text{ m}^2 \quad \checkmark$$

$$P = \frac{F}{A} \quad \checkmark$$

$$P = \frac{20 \times 10^3}{13,273228 \times 10^{-3}}$$

$$P = 1506792,36 \text{ Pa} \quad \checkmark$$

(3)

9.3.2 **Force needed on piston A:**

$$A_A = \frac{\pi D^2}{4}$$

$$A_A = \frac{\pi \times (0,03)^2}{4}$$

$$A_A = 0,000706858 \text{ m}^2$$

$$A_A = 0,706858 \times 10^{-3} \text{ m}^2 \quad \checkmark$$

$$P = \frac{F}{A} \quad \checkmark$$

$$F = P \times A \quad \checkmark$$

$$F = (1506792,36) \times (0,706858 \times 10^{-3}) \quad \checkmark$$

$$F = 1065,09 \text{ N} \quad \checkmark$$

OR

$$\frac{F_A}{A_A} = \frac{F_B}{A_B} \quad \checkmark$$

$$F_A = \frac{F_B \times A_A}{A_B} \quad \checkmark$$

$$= \frac{2000 \times 10 \times 0,706858 \times 10^{-3}}{13,273228 \times 10^{-3}} \quad \checkmark$$

$$= 1065,09 \text{ N} \quad \checkmark$$

(4)

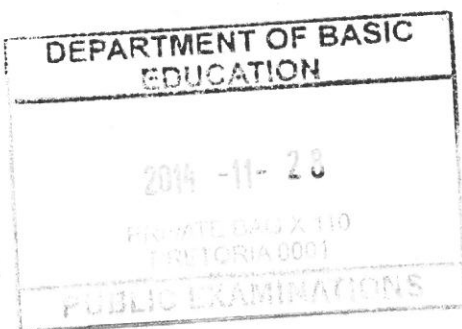

9.4 Functioning of vehicle management system:

- Electronic systems use sensors to supply ECU with data. ✓
- The sensor data is read and compared with pre-programmed information. ✓
- A response is calculated and actuators are adjusted. ✓
- The results are checked and the process is repeated. ✓

(4)

9.5 Anti-lock brake system:

ABS comes into play in poor road surface and weather conditions ✓ and also during emergency stops. ✓

(2)

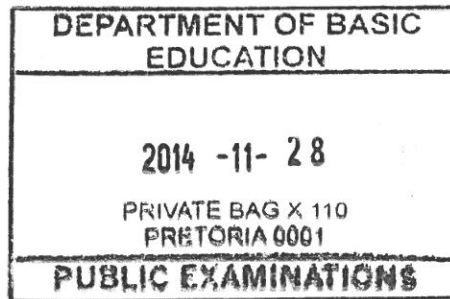
[25]

QUESTION 10: TURBINES

10.1 Turbine:

A steam turbine is a mechanical device that extracts thermal energy ✓ from pressurised steam and converts it into mechanical work / rotary motion. ✓ (2)

10.2 Supercharger terminology:

10.2.1 Boost:

This refers to the increase in manifold pressure that is generated by the turbocharger in the intake path or specifically intake manifold which exceeds normal atmospheric pressure. ✓✓ (2)

10.2.2 Density ratio:

The density of the inlet air compared to the density of the outlet air in comparison to the inlet manifold. ✓✓ (2)

10.3 Water turbine:

10.3.1 Reaction turbine / Water turbine / Kaplan turbine ✓ (1)

10.3.2 A – Wicket gate ✓

B – Rotor ✓

C – Stator ✓

D – Shaft ✓

E – Water-flow / Inlet port ✓

F – Blades / Vanes / Propeller / Fins / Turbine wheel ✓ (6)

Advantages of water turbine:

- Water turbines do not emit carbon. ✓
- No water is consumed in the process of generating electricity. ✓
- Water turbines are more reliable. ✓
- Water turbine blades continue to turn on cloudy windless days unlike sun and wind systems. ✓
- It is environmental friendly with no pollution. ✓
- More economical than steam turbines ✓

(Any 3x1) (3)

10.4 Waste gate:

A waste gate is a valve that diverts exhaust gases away from the turbine wheel. It regulates the turbine speed, rotating speed of the compressor as well as regulates maximum boost pressure in the turbocharger system. ✓✓

10.5 Oil cooler:

To cool the oil that lubricates the turbocharger bearings. ✓ and shaft ✓ (2)

[20]

TOTAL: 200

