

**INSTRUCTIONS TO MARKERS**

1. All questions with multiple answers imply that any relevant, acceptable answer should be considered.
2. Calculations:
  - 2.1 All calculations must show the formula(e).
  - 2.2 Substitution of values must be done correctly
  - 2.3 All answers **MUST** contain the correct unit to be considered.
  - 2.4 Alternative methods must be considered, provided that the same answer is obtained.
  - 2.5 Where an erroneous answer could be carried over to the next step, the first answer will be deemed incorrect. However, should the incorrect answer be carried over correctly, the marker has to re-calculate the values, using the incorrect answer from the first calculation. If correctly used, the learner should receive the full marks for subsequent calculations
3. The memorandum is only a guide with model answers. Alternative interpretations must be considered, and marked on merit. However, this principle should be applied consistently throughout the marking session at ALL marking centers.

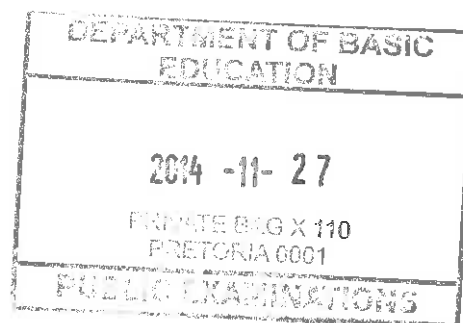
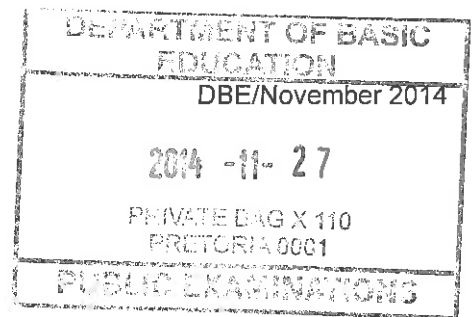

**QUESTION 1: OCCUPATIONAL HEALTH AND SAFETY**

- 1.1 Faulty plug points ✓  
Exposed conductors.  
Poor lighting when conducting a live installation inspection (1)
- 1.2 Working on a live system with exposed conductors without necessary precaution. ✓  
Working with portable electric equipment that is not insulated.  
Using electrical machines without using the required safety equipment or clothing. (1)
- 1.3 First aid must be immediately given to any injured person. ✓  
The situation must be immediately assessed and the person designated to deal with the emergencies must be informed.  
Apply direct pressure or use a pressure bandage if the person is bleeding  
Keep the victim calm (1)
- 1.4 A person under the influence of drugs may place himself and other persons ✓  
in danger as his judgement may be impaired which could lead to an accident. ✓ This infringes on co-workers rights to work in a safe environment. (2)
- 1.5 Team work creates a healthy and successful environment in which to work, ✓  
it creates cooperation and respect between people ✓  
It promotes productivity and secure employment (2)
- 1.6 Risk analysis is a process that will help people adopt a policy of safe practices as an ongoing process ✓ As projects in a workshop change according to people's needs the manufacturing processes also has to change and safety practices ✓ must be included in all stages of planning. ✓ (3)
- [10]**

**QUESTION 2: THREE-PHASE AC GENERATION**

- 2.1 Transformers are connected in delta because it is a three phase three wire system ✓ as opposed to a three phase four wire system which results in a huge cost saving. ✓  
Working on the transmission lines will be less labour intensive due to the reduction in the number of lines which results in a huge cost saving. (2)
- 2.2 The purpose of a power factor meter is to indicate the power factor ratio ✓  
between the current and applied voltage in an AC circuit ✓  
Reference to reactive power also to be considered. (2)
- 2.3 Three phase system can be operated in delta or in star. ✓  
When they are connected in delta, a neutral point is not required. ✓  
In star a phase and line voltage of different values are obtained.  
Load distribution is possible due to multiple phases. (2)

2.4 2.4.1  $P_T = P_1 + P_2$  ✓  
 $= 420 + (-260)$  ✓  
 $= 160 \text{ W}$  ✓ (3)

2.4.2 The total power can be measured in a balanced or unbalanced load ✓  
 The total power can be measured in a star or delta system ✓  
 The power factor can be determined (2)

2.5 2.5.1  $I_L = \frac{P}{\sqrt{3} V_L \cos\theta}$  ✓  
 $= \frac{560000}{\sqrt{3} \times 380 \times 0.85}$  ✓  
 $= 1000,98 \text{ A}$  ✓ (3)

2.5.2

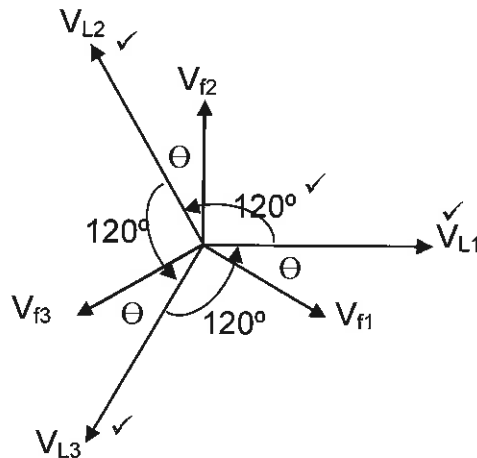

One mark for showing  $V_{ph}$  is smaller than  $V_L$  ✓  
 $V_{ph}$  lags  $V_L$  ✓  
 by  $\theta = 30$  degrees

Learners only showing 3 Line voltages and angles ( $120^\circ$ ) will get full marks.

If learners show a Phasor diagram with voltages and currents shown correctly they will also get full marks.

(6)  
[20]

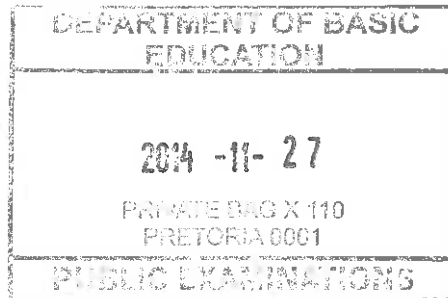

**QUESTION 3: THREE-PHASE TRANSFORMERS**

- 3.1 Star-delta✓  
Delta-star✓  
Star-star  
Delta-delta (2)

3.2 An alternating voltage is connected across the primary windings resulting in an alternating current flowing through the primary winding.✓  
 Alternating current flowing through the primary winding induces an alternating magnetic field around the primary winding.(Faraday's Law) ✓  
 This expanding and collapsing magnetic field causes mutual induction from the primary to the secondary winding of the transformer via a laminated core.✓  
 The relative change between the magnetic field and the windings results in an EMF being induced in the secondary winding. ✓  
 When the transformer is connected to a load, the load determines how much current is drawn from the secondary winding. ✓  
 Loading of the secondary winding is transferred to the primary winding through mutual induction. A rise in load demand will increase the power drawn from the supply on the primary side of the transformer.  
 The primary winding of a transformer is magnetically coupled to the secondary winding and electrically insulated from the secondary winding, with the exception of an autotransformer. (5)

3.3 The Bucholtz relay protects ✓ the transformer under internal fault conditions.✓ (2)

3.4 3.4.1  $V_{LS} = \sqrt{3} \times V_{PhS}$   
 $V_{PhS} = \frac{V_{LS}}{\sqrt{3}}$  ✓  
 $= \frac{380}{\sqrt{3}}$  ✓  
 $= 219,39 \text{ V}$  ✓ (3)

3.4.2  $\frac{N_P}{N_S} = \frac{V_{Ph(P)}}{V_{Ph(S)}}$   
 $V_{Ph(P)} = \frac{N_P \times V_{Ph(S)}}{N_S}$  ✓  
 $= \frac{50 \times 219,39}{1}$  ✓  
 $= 10,969 \text{ kV}$  ✓ (3)

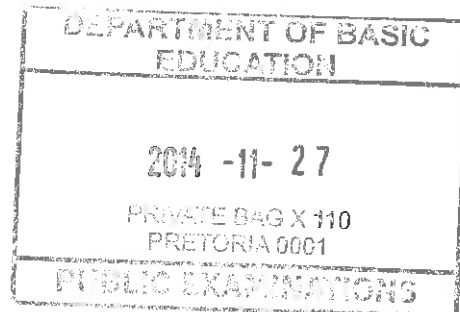

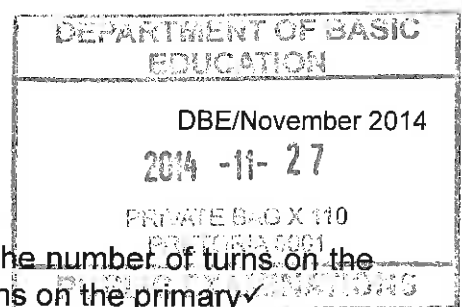

- 3.4.3 The transformer is a step down because the number of turns on the secondary is less ✓ than the number of turns on the primary ✓  
Reference to voltage ratio must also be considered. (2)
- 3.4.4 When the load is increased, the increased current drawn from the secondary winding will increase the mutual inductance ✓ with the primary winding, thus increasing the primary current. ✓  
The voltages in both the primary and secondary windings remain unchanged. ✓ (3)

[20]

**QUESTION 4: THREE-PHASE MOTORS AND STARTERS**

- 4.1 Drives pumps ✓  
Drives conveyor belts (1)
- 4.2 They require less maintenance as they do not have as many parts as a single phase motor ✓  
For the same size frame as a single phase motor they deliver a higher torque. (1)
- 4.3 A three-phase voltage supply is connected across the stator windings ✓  
This sets up three-phase currents in the stator windings ✓  
The currents flowing in the stator windings set up a rotating magnetic field in the stator windings ✓  
The rotating magnetic field set up in the stator sweeps across the squirrel cage conductors ✓  
Due to the relative motion between the conductors and the rotating magnetic field an EMF is induced across the rotor conductors ✓  
This sets up currents in the rotor conductors ✓  
This creates a magnetic field in and around the rotor ✓  
The two magnetic fields interact causing a force to be exerted between them  
This force creates a torque on the rotor which results in the rotor rotating ✓ (8)
- 4.4 Does the rotor turn freely? ✓  
Are the bearings squeaky or do they feel rough when the shaft is turned by hand?  
Is the motor mounted securely and are the bolts tightened properly?  
Is the cooling fan intact or do some of the fins appear chipped?  
Are the end plates fastened properly?  
Does the frame have any cracks? (1)
- 4.5 Continuity of each winding ✓  
Insulation resistance between each winding  
Insulation resistance between windings and earth  
Visual inspection for exposed windings (1)
- 4.6 4.6.1 Rotor speed is the speed of the rotor shaft ✓ (1)
- 4.6.2 Synchronous speed is the speed of the rotating magnetic field set up in the stator ✓ (1)

- 4.7  $V_L = 380\text{ V}$   
 $f = 50\text{ Hz}$   
 Slip = 4%  
 Number of poles = 12  
 Number poles per phase = 4  
 Pole pairs = 2 or 6 (if interpreted as 12 poles per phase)

4.7.1  $n_s = \frac{f}{p} \times 60 \checkmark$   
 $n_s = \frac{50}{2} \times 60 \checkmark$   
 $n_s = 1500\text{ rpm} \checkmark$

OR

$n_s = \frac{f}{p} \times 60$

$n_s = \frac{50}{6} \times 60$   
 $n_s = 500\text{ rpm}$

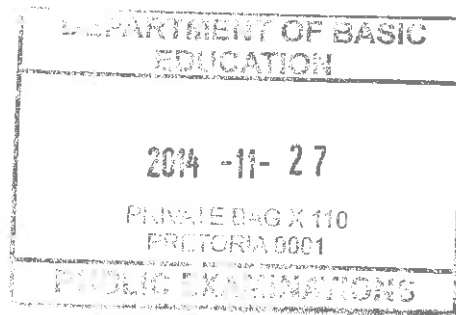

(3)

4.7.2  $n_r = n_s (1 - S) \checkmark$   
 $n_r = 1500 (1 - 0.04) \checkmark$   
 $n_r = 1440\text{ r/min} \checkmark$   
 OR  
 $n_r = n_s (1 - S)$   
 $n_r = 500 (1 - 0.04)$   
 $n_r = 480\text{ r/min}$

(3)

- 4.8 4.8.1

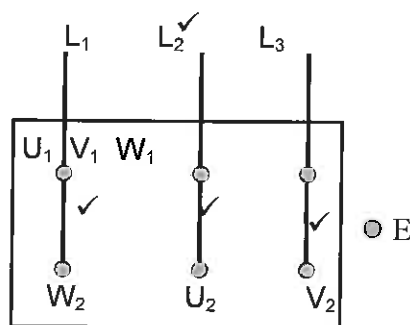

(4)

- 4.8.2 A reading of over  $1\text{M } \Omega$  (very High) or  $500\text{M } \Omega$ .  $\checkmark$  This will indicate that there is no breakdown of insulation  $\checkmark$  between earth and the winding  $\checkmark$  which means that the electrical integrity of the motor is intact.

(3)

- 4.9 A star-delta is used to reduce the starting current  $\checkmark$  of an electrical motor at start. At start a motor tends to draw more than its rated full load  $\checkmark$  current. This causes unnecessary tripping.  $\checkmark$

(3)

- 4.10 A forward reverse starter swops the connections  $\checkmark$  of any two supply windings  $\checkmark$  changing the direction of the magnetic field

(2)

- 4.11 4.11.1 The timer determines the time ✓ when the second motor is switched on after the first motor. ✓ (2)
- 4.11.2 When the start button is depressed this will energise the coil of the contactor that starts motor 1 ✓  
 The contactor MC<sub>1</sub> will now close starting motor 1 ✓  
 The N/O of MC<sub>1</sub> (hold in) will close keeping the contactor closed when the start button is released ✓  
 The N/O of MC<sub>1</sub> (hold out) will now close energising the timer coil ✓  
 The timer contactor will begin to time through ✓  
 After one minute the N/O on the timer will close energising the coil of contactor 2 starting motor 2 ✓ (6)

[40]

**QUESTION 5: RLC**

- 5.1 5.1.1 Resonance in a RLC circuit is a condition at a specific frequency where  $X_L = X_C$ , ✓ this results in the current and voltage to be in phase therefore a phase angle of 0°. ✓ (2)

- 5.1.2 Q-factor in a parallel circuit is the relation between the current in the reactive components to the supply current. It is the current magnification ✓ that occurs at resonance ✓

The quality factor is the ratio of the supply voltage and the voltages across the reactive components of a RLC circuit during resonance. Energy stored as apposed to energy wasted. (2)

- 5.2 5.2.1 When  $X_L = X_C$

$$C = \frac{1}{2\pi f X_C} \quad \checkmark$$

$$= \frac{1}{2 \times \pi \times 50 \times 157} \quad \checkmark$$

$$= 20,27 \mu\text{F} \quad \checkmark$$

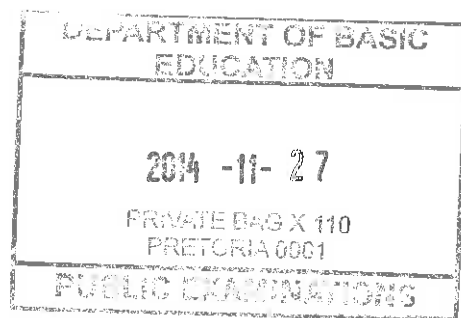

(3)

5.2.2  $Q = \frac{X_L}{R} \quad \checkmark$

$$= \frac{157}{4} \quad \checkmark$$

$$= 39,25 \quad \checkmark$$

(3)

5.3 5.3.1  $I_C = \frac{V_C}{X_C}$  in parallel  $V_C = V_T \quad \checkmark$

$$= \frac{120}{26} \quad \checkmark$$

$$= 4,62 \text{ A} \quad \checkmark$$

(3)

$$\begin{aligned}
 5.3.2 \quad I_T &= \sqrt{I_R^2 + (I_C - I_L)^2} && \checkmark \\
 &= \sqrt{4^2 + (4,62 - 1,76)^2} && \checkmark \\
 &= 4,92 \text{ A} && \checkmark
 \end{aligned}$$

(3)

$$\begin{aligned}
 5.3.3 \quad \cos\theta &= \frac{I_R}{I_T} && \checkmark \\
 &= \frac{4}{4,92} && \checkmark \\
 &= 0,813 && \checkmark \\
 \theta &= 35,6^\circ && \checkmark \\
 &\text{Leading} && \checkmark
 \end{aligned}$$

(4)  
[20]

**QUESTION 6: LOGIC**

- 6.1 6.1.1 A PLC is a computer $\checkmark$  used for automation $\checkmark$  of electrical and mechanical processes $\checkmark$   
A PLC is a solid state device used to automate machines in industry. (3)
- 6.1.2 Relays are commonly used as an output interface $\checkmark$  which carries a much higher current than the PLC is designed to handle $\checkmark$ , therefore it is used as a switching device to control electrical equipment $\checkmark$ . (3)
- 6.1.3 Economical $\checkmark$   
Simplified design $\checkmark$   
Quick delivery $\checkmark$   
Compact and standardised  
Improved reliability  
Reduced maintenance (3)
- 6.1.4 Logic block diagram/Functional Blocks are easier to manipulate using Boolean algebra $\checkmark$  to minimise the input. This results in cost-saving.  $\checkmark$   
**Two marks to all learners! – Function blocks not specified its advantages and disadvantages.** (2)

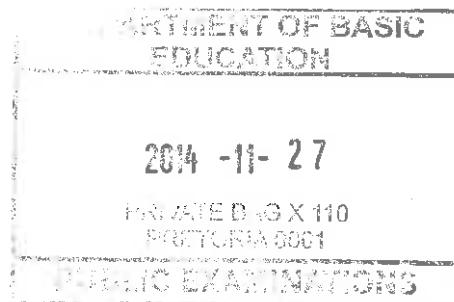



6.2 6.2.1 A programming device is used to give an input to the CPU ✓ and to display ✓ the operation of the CPU ✓  
 A programming device is used to read the input information and send it in a digital format to the CPU and to display the output of the CPU  
 A programming device is used to enter the necessary programme that will determine the sequence of events in the memory of the processor (3)

6.2.2 A Personal computer ✓  
 A hand held programming device ✓  
 A programming cable  
 It can be done directly on the PLC (2)

6.3 6.3.1  

$$Y = (X_0 \cdot X_2) \cdot (\bar{X}_1 + \bar{Y}_0)$$
 Acceptable if the functions were inverted with respect to  $X_0$ ,  $X_2$  and  $X_1$  and  $Y_0$  (5)

6.3.2

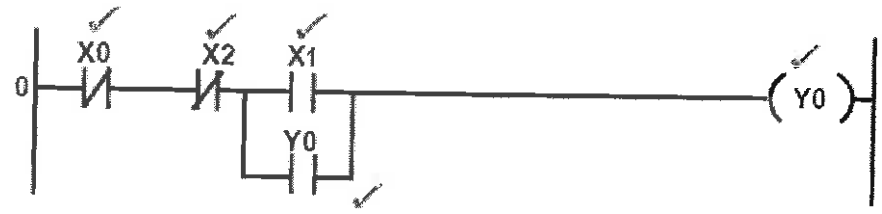

or with all inputs show as N/O.

6.4. 6.4.1  $D = \bar{A}\bar{B}\bar{C}$  ✓ (1)  
 6.4.2  $E = A\bar{B}\bar{C}$  ✓ (1)  
 6.4.3  $F = A.\bar{B}.\bar{C}$  ✓ (1)  
 6.4.4  $G = \bar{A}.\bar{B}.\bar{C}$  ✓ (1)  
 6.4.5  $X = \bar{A}\bar{B}\bar{C} + A\bar{B}\bar{C} + A\bar{B}.C + \bar{A}.B.C$  ✓ (1)

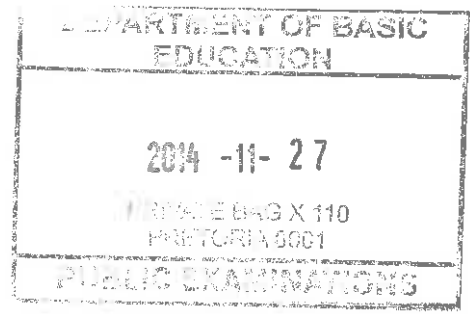

6.4.6

		AB			
		00	01	11	10
0	✓	1 ✓	1 ✓	1 ✓	1 ✓
1		0	0	0	0

**NOTE:** 1 mark is for selecting all the 1's

$X = \bar{C}$  ✓

OR

		$\bar{A}\bar{B}$	$\bar{A}B$	$AB$	$A\bar{B}$
$\bar{C}$	✓	1	1	1	1
C		0	0	0	0

A variance on the allocation of A, B and C must be accommodated as well. However x remains as is.

(6)

6.5 A PLC system operates on low current ✓ as opposed to a high current system ✓ and changes are made via a program in place of a hard wire change ✓.

Simulations of the operation of any factory or plant may be done using a computer program and any faults or programming errors could be rectified in a step by step manner.

(3)  
[40]

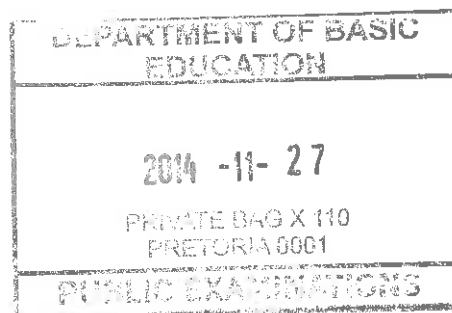

**QUESTION 7: AMPLIFIERS**

- 7.1 Open-loop voltage gain  $A_V = \text{infinite}$  ✓  
 Input impedance  $Z_{in} = \text{infinite}$  ✓  
 Output impedance  $Z_o = \text{zero}$  ✓  
 Bandwidth = infinite  
 Unconditional stability  
 Differential inputs, i.e. two inputs  
 Infinite common-mode rejection (3)
- 7.2 A differential amplifier will only amplify the difference between two input signals. ✓ If they are the same no amplification will take place. ✓ (2)
- 7.3 Alternatively: Learners may have drawn an inverting amplifier.

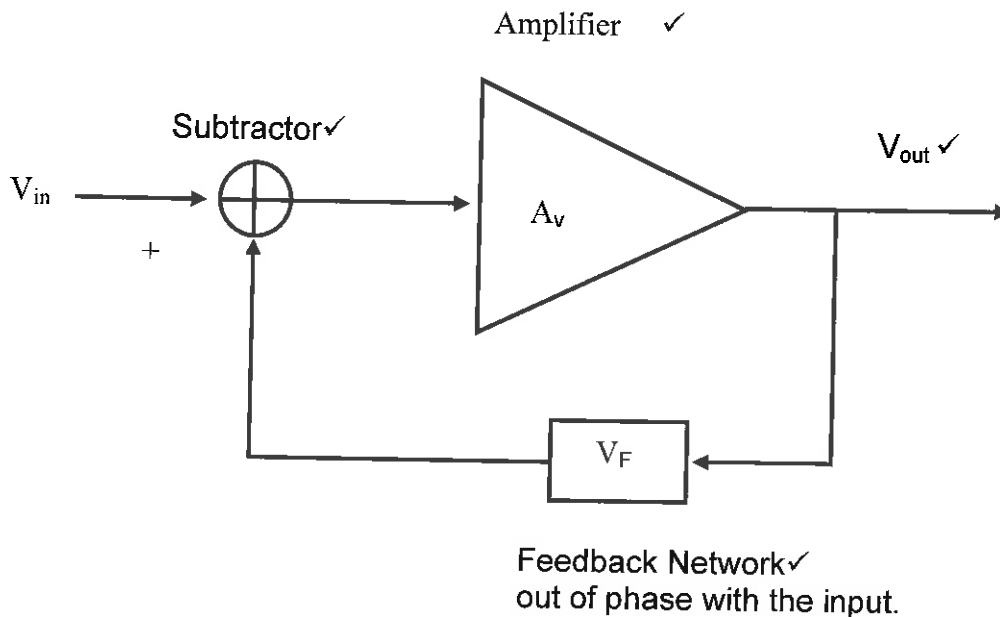

- 7.4 The bandwidth is increased. ✓  
 The level of noise (hiss) is decreased ✓  
 The gain is decreased  
 The deformation of the input signal is reduced (4)
- 7.5 The dual DC supply supplies energy ✓ to the op-amp to enable amplification. The dual DC supply sets the voltage parameters both positive and negative ✓.  $+V_{cc}$  and  $-V_{cc}$  are the maximum voltages to which any input signal could be amplified. ✓ (3)

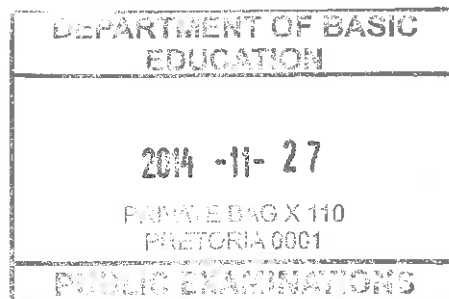

7.6 7.6.1 Inverting amplifier ✓

(1)

7.6.2



Must show amplification ✓ and inversion ✓  
Alternatively:

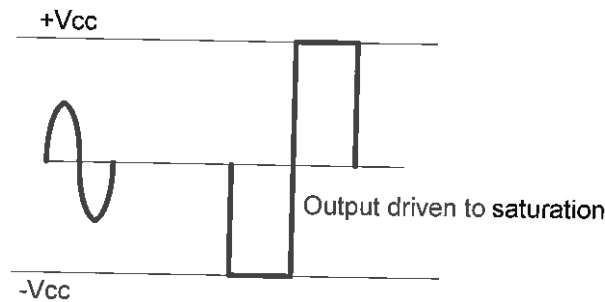

(2)

7.6.3 If the resistance of the feedback resistor  $R_f$  is decreased the gain of amplifier will also decrease ✓ as the negative feedback is increased ✓

(2)

7.6.4  $A_v = -\frac{R_f}{R_{in}}$  ✓  
 $= -\frac{15}{5}$  ✓  
 $= -3$  ✓

(3)

7.6.5  $A_v = \frac{V_{out}}{V_{in}}$  ✓  
 $V_{out} = A_v V_{in}$  ✓  
 $= -3 \times 1$   
 $= -3 \text{ V}$  ✓

(3)

7.7 7.7.1 Summing amplifier ✓

(1)

7.7.2 The summing amplifier is often used as a mixer in audio circuits ✓ when more than one signal is applied to the input simultaneously. ✓ The output then becomes the sum of these input signals, from a microphone, an electric guitar or a keyboard. ✓

(3)

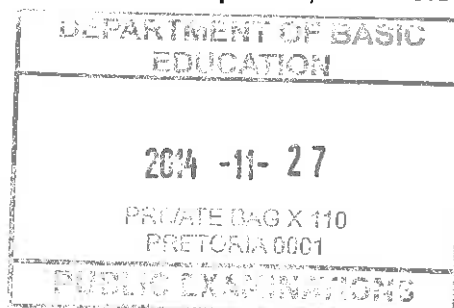

7.7.3  $V_{out} = -(V_1 + V_2 + V_3)$  ✓  
 $= -(4 - 1 + 2)$  ✓  
 $= -5V$  ✓

Alternative

$V_{out} = (V_1 + V_2 + V_3)$   
 $= (4 - 1 + 2)$   
 $= 5V$

Formulasheet did not indicated inverting vs non-inverting amplifier.

(3)

7.8 7.8.1 Astable multivibrators are used in any system that requires a square wave. ✓  
 Morse keyers in amateur radio equipment use an astable multivibrator to generate an 800 Hz tone for transmitting Morse code ✓.  
 Clock pulse generator.

(2)

7.8.2

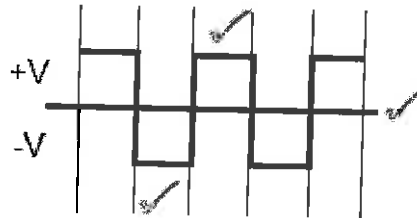

(3)

7.9 7.9.1 Day night switches (Comparator Circuit) ✓  
 When the light intensity changes at dusk, the input voltage from the light sensor drops below the reference voltage. ✓  
 The result is that the output of the Schmidt trigger is changed to switch a light on. ✓

OR

Wave Shaping Circuits – (Square Wave recovery Circuit). The Schmidt trigger acts as a square wave generator.

When an input signal reaches either an upper or lower threshold level the Schmitt trigger swings into an upper or lower saturation point.

This process recovers a 'cleaned up' square wave from the input.

The Schmidt trigger can also be used to recover a block pulse that has been distorted because of pollution and noise introduced during transmission.

(3)

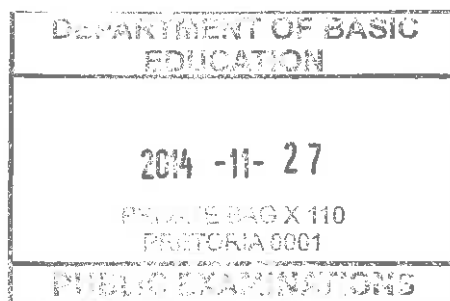

7.9.2

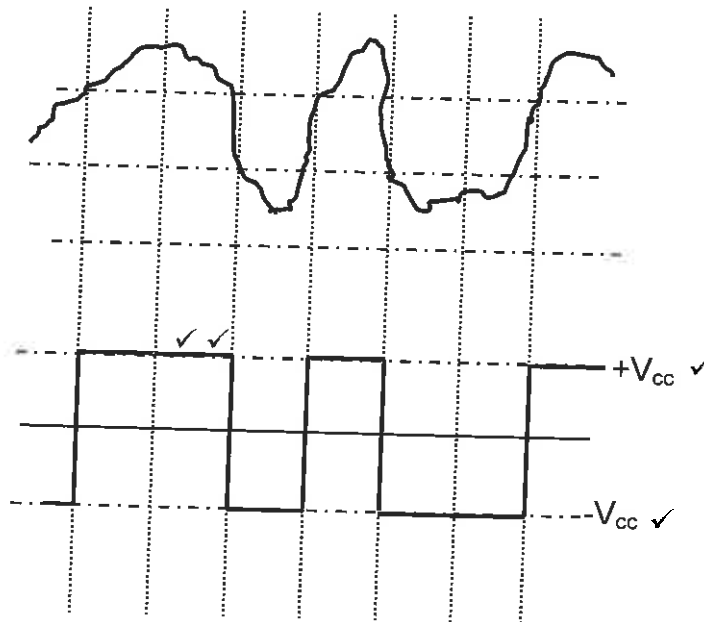

Alternative – Inverse also acceptable as the type of Schmidt Trigger not specified (Inverting vs non-inverting Schmidt Trigger.) (4)

7.10 Oscillators use positive feedback. ✓ (1)

7.11 Positive feedback is where a portion of the output is fed back into the input ✓ and added to the input signal. ✓ The feedback signal and input signal are in phase with each other, thus increasing the gain. (2)

7.12

$$f = \frac{1}{2\pi\sqrt{6RC}} \quad \checkmark$$

$$= \frac{1}{2\pi\sqrt{6 \times (8 \times 10^3) \times (120 \times 10^{-9})}} \quad \checkmark$$

$$= \frac{1}{2\pi\sqrt{(5,76 \times 10^{-3})}} \quad \checkmark$$

$$= 2,09 \text{ Hz} \quad \checkmark$$

(3)  
[50]

TOTAL: 200

