



basic education

Department:
Basic Education
REPUBLIC OF SOUTH AFRICA

SENIOR CERTIFICATE EXAMINATION SENIORSERTIFIKAAT-EKSAMEN

**PHYSICAL SCIENCES: PHYSICS (P1)
FISIESE WETENSKAPPE: FISIKA (V1)**

2017

MARKING GUIDELINES/NASIENRIGLYNE

MARKS/PUNTE: 150

**These marking guidelines consist of 23 pages.
Hierdie nasienriglyne bestaan uit 23 bladsye.**

QUESTION/VRAAG 1

- | | | |
|------|------|-------------|
| 1.1 | D ✓✓ | (2) |
| 1.2 | B ✓✓ | (2) |
| 1.3 | D ✓✓ | (2) |
| 1.4 | C ✓✓ | (2) |
| 1.5 | D ✓✓ | (2) |
| 1.6 | B ✓✓ | (2) |
| 1.7 | C ✓✓ | (2) |
| 1.8 | C ✓✓ | (2) |
| 1.9 | B ✓✓ | (2) |
| 1.10 | B ✓✓ | (2) |
| | | [20] |

QUESTION/VRAAG 2

2.1.1

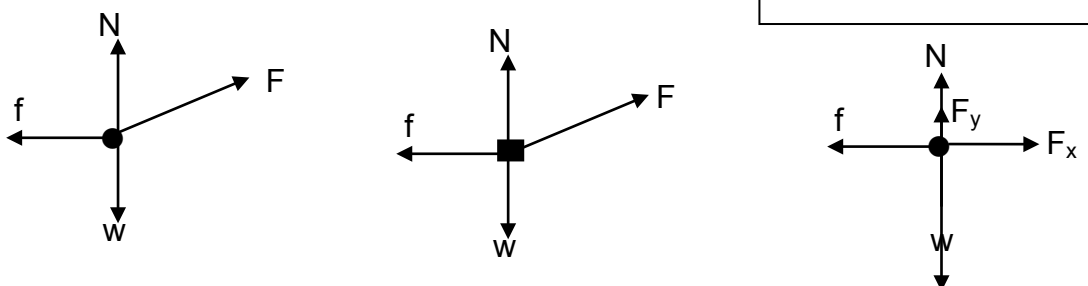

Accepted labels/Aanvaarde benoemings		
w	F_g/F_w /weight/mg/gravitational force F_g/F_w /gewig/mg/gravitasiekrag	✓
f	Friction/ $F_f/f_k/3$ N/wrywing/ F_w	✓
N	Normal (force)/ F_{normal} / $F_N/F_{normaal}/F_{reaction}$ /reaksie	✓
F	$F_A/F_{applied}$ /toegepas	✓

Notes/Aantekeninge

- Mark awarded for label and arrow/*Punt toegeken vir benoeming en pyltjie*
- Deduct 1 mark if arrow(s) is (are) missing/*Trek 1 punt af indien pylpunt(e) nie aangeheg is nie*
- Do not penalise for length of arrows since drawing is not to scale./*Moenie vir die lengte van die pyltjies penaliseer nie aangesien die tekening nie volgens skaal is nie*
- Any other additional force(s)/*Enige ander addisionele krag(te) Max/Maks $\frac{3}{4}$*
- If force(s) do not make contact with body/*Indien krag(te) nie met die voorwerp kontak maak nie: Max/Maks: $\frac{3}{4}$*

(4)

2.1.2 $f_k = \mu_k N$ ✓ (can use F_N for N in equation/ kan F_N vir N gebruik in vergelyking)

$3 = (0,2)N$ ✓

$N = 15 \text{ N}$ ✓

(3)

2.1.3 **POSITIVE MARKING FROM QUESTION 2.1.2****POSITIEWE NASIEN VANAF VRAAG 2.1.2**

$F_{net} = ma$

$N + F_{vert} - w = 0$

$N + F_{vert} = w$

✓ any of the three/*enige van die drie*

$F \sin 20^\circ = (2)(9,8) - 15$ ✓

$F = 13,45 \text{ N}$ ✓

(4)

2.1.4 **POSITIVE MARKING FROM QUESTION 2.1.3****POSITIEWE NASIEN VANAF VRAAG 2.1.3**

$F_{net} = ma$

$F \cos 20^\circ - f = ma$

✓ any of the two/*enige van die twee*

$13,45 \cos 20^\circ - 3 = 2a$ ✓

$a = 4,82 \text{ m.s}^{-2}$ ✓

(3)

2.2

2.2.1 Any two particles (objects) in the universe will attract each other with a force which is directly proportional to the product of the masses ✓ and inversely proportional to the square of the distance between them (their centres). ✓

Enige twee deeltjies (voorwerpe) in die heelal sal mekaar aantrek met 'n krag wat direk eweredig is aan die produk van hul massas en omgekeerd eweredig is aan die kwadraat van die afstand tussen hul (middelpunte). (2)

2.2.2 Increases/Neem toe ✓

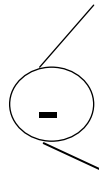

Gravitational force is inversely proportional to the square of the distance between the (centres of the) objects ✓

Gravitasiekrag is omgekeerd eweredig aan die kwadraat van die afstand tussen die voorwerpe se middelpunte

OR/OF

$$F \propto \frac{1}{r^2} \checkmark$$

(2)
[18]

QUESTION/VRAAG 3

3.1 The only force acting on the ball is the gravitational force. ✓✓

Die enigste krag wat op die bal inwerk is die gravitasiekrag.

OR/OF

The only force acting on the ball is its weight.

Die enigste krag wat op die bal inwerk is sy gewig.

ACCEPT/AANVAAR

The only force acting on the ball is gravity.

Die enigste krag wat op die bal inwerk is gravitasie. (2)

3.2.1

<p>OPTION 1/OPSIE 1 UPWARDS AS POSITIVE OPWAARTS AS POSITIEF $\Delta y = v_i \Delta t + \frac{1}{2} a \Delta t^2 \checkmark$ $= (10)(3) + \frac{1}{2}(-9,8)(3^2) \checkmark$ $= -14,10$ Height of building = 14,10 m ✓ <i>Hoogte van gebou = 14,10 m</i></p>	<p>DOWNWARDS AS POSITIVE AFWAARTS AS POSITIEF $\Delta y = v_i \Delta t + \frac{1}{2} a \Delta t^2 \checkmark$ $= (-10)(3) + \frac{1}{2} (9,8)(3^2) \checkmark$ $= 14,10 \text{ m } \checkmark$ Height of building = 14,10 m <i>Hoogte van gebou = 14,10 m</i></p>
---	--

<p>OPTION 2/OPSIE 2 UPWARD AS POSITIVE OPWAARTS AS POSITIEF For maximum height <i>Vir maksimum hoogte</i> $v_f = v_i + a \Delta t$ $0 = 10 + (-9,8) \Delta t$ $\Delta t = 1,02 \text{ s}$ Time taken from point A to ground <i>Tyd geneem vanaf punt A tot grond</i> $= 3 - 2(1,02) = 0,96 \text{ s}$ $\Delta y = v_i \Delta t + \frac{1}{2} a \Delta t^2 \checkmark$ $= (-10)(0,96) + \frac{1}{2} (-9,8)(0,96^2) \checkmark$ $= -14,1184$ Height of building = 14,12 m ✓ <i>Hoogte van gebou = 14,12 m</i></p>	<p>UPWARD AS NEGATIVE OPWAARTS AS NEGATIEF For maximum height <i>Vir maksimum hoogte</i> $v_f = v_i + a \Delta t$ $0 = -10 + (9,8) \Delta t$ $\Delta t = 1,02 \text{ s}$ Time taken from point A to ground <i>Tyd geneem vanaf punt A tot grond</i> $= 3 - 2(1,02) = 0,96 \text{ s}$ $\Delta y = v_i \Delta t + \frac{1}{2} a \Delta t^2 \checkmark$ $= (10)(0,96) + \frac{1}{2} (9,8)(0,96^2) \checkmark$ $= 14,1184 \text{ m } \checkmark$ Height of building = 14,12 m <i>Hoogte van gebou = 14,12 m</i></p>
--	--

<p>OPTION 3/OPSIE 3 UPWARD AS POSITIVE OPWAARTS AS POSITIEF $v_f = v_i + a \Delta t$ $= 10 + (-9,8)(3)$ $= -19,40$ $v_f^2 = v_i^2 + 2 a \Delta y \checkmark$ $(-19,4)^2 = (10)^2 + 2(-9,8) \Delta y \checkmark$ $\Delta y = -14,10 \text{ m}$ Height of building = 14,10 m ✓ <i>Hoogte van gebou = 14,10 m</i></p>	<p>UPWARD AS NEGATIVE OPWAARTS AS NEGATIEF $v_f = v_i + a \Delta t$ $= -10 + (9,8)(3)$ $= 19,40$ $v_f^2 = v_i^2 + 2 a \Delta y \checkmark$ $(19,4)^2 = (-10)^2 + 2(9,8) \Delta y \checkmark$ $\Delta y = 14,10 \text{ m } \checkmark$ Height of building = 14,10 m <i>Hoogte van gebou = 14,10 m</i></p>
--	--

<p>OPTION 4/OPSIE 4 UPWARD AS POSITIVE OPWAARTS AS POSITIEF</p> $v_f = v_i + a\Delta t$ $= (-10) + (-9,8)(0,96)$ $= -19,408$ $v_f^2 = v_i^2 + 2 a\Delta y \checkmark$ $(-19,408)^2 = (10)^2 + 2(-9,8)\Delta y \checkmark$ $\Delta y = 14,12 \text{ m}$ Height of building = 14,12 m ✓ Hoogte van gebou = 14,12 m	<p>UPWARD AS NEGATIVE OPWAARTS AS NEGATIEF</p> $v_f = v_i + a\Delta t$ $= 10 + (9,8)(0,96)$ $= 19,408$ $v_f^2 = v_i^2 + 2 a\Delta y \checkmark$ $(19,408)^2 = (-10)^2 + 2(9,8)\Delta y \checkmark$ $\Delta y = 14,12 \text{ m} \checkmark$ Height of building = 14,12 m Hoogte van gebou = 14,12 m
---	---

<p>OPTION 5/OPSIE 5</p> $W_{\text{net}} = \Delta E_k = \Delta K$ $mg\Delta x \cos 0^\circ = \frac{1}{2} m(v_f^2 - v_i^2)$ $(9,8)\Delta x = \frac{1}{2} (19,408^2 - 10^2) \checkmark$ $\Delta x = 14,12 \text{ m}$ Height of building = 14,12 m ✓ Hoogte van gebou = 14,12 m	<div style="border: 1px solid black; padding: 5px; width: fit-content; margin: 0 auto;">✓ any one/enige een</div> $v_f = v_i + a\Delta t$ $= 10 + (9,8)(3)$ $= 19,40$
---	--

<p>OPTION 6/OPSIE 6</p> $E_{\text{mechA}} = E_{\text{mechB}}$ $(E_k + E_p)_A = (E_k + E_p)_B$ $\frac{1}{2} mv^2 + mgh = \frac{1}{2} mv^2 + 0$ $\frac{1}{2}(10)^2 + (9,8)h = \frac{1}{2}(19,40)^2 \checkmark$ Height of building = 14,12 m ✓ Hoogte van gebou = 14,12 m	<div style="border: 1px solid black; padding: 5px; width: fit-content; margin: 0 auto;">✓ any one/enige een</div> $v_f = v_i + a\Delta t$ $= 10 + (9,8)(3)$ $= 19,40$
--	--

<p>OPTION 7/OPSIE 7</p> $W_{\text{nc}} = \Delta E_p + \Delta E_k \checkmark$ $0 = mg(h_f - h_i) + \frac{1}{2}m(v_f^2 - v_i^2)$ $0 = m(9,8)(0 - h_i) + \frac{1}{2}m(19,408^2 - 10^2) \checkmark$ Height of building = 14,12 m ✓ Hoogte van gebou = 14,12 m	<div style="border: 1px solid black; padding: 5px; width: fit-content; margin: 0 auto;"> $v_f = v_i + a\Delta t$ $= 10 + (9,8)(3)$ $= 19,40$ </div>
---	--

<p>OPTION 8/OPSIE 8 UPWARD AS POSITIVE OPWAARTS AS POSITIEF</p> $v_f = v_i + a\Delta t$ $= (10) + (-9,8)(3)$ $= -19,40 \text{ m}\cdot\text{s}^{-1}$ $\Delta y = \frac{v_i + v_f}{2} \Delta t \checkmark$ $\Delta y = \frac{(10 - 19,40)}{2} \cdot 3 \checkmark$ Height of building = 14,12 m ✓ Hoogte van gebou = 14,12 m	<p>UPWARD AS NEGATIVE OPWAARTS AS NEGATIEF</p> $v_f = v_i + a\Delta t$ $= 10 + (9,8)(3)$ $= 19,40 \text{ m}\cdot\text{s}^{-1}$ $\Delta y = \frac{v_i + v_f}{2} \Delta t \checkmark$ $\Delta y = \frac{(-10 + 19,40)}{2} \cdot 3 \checkmark$ $\Delta y = 14,12 \text{ m} \checkmark$ Height of building = 14,12 m Hoogte van gebou = 14,12 m
--	--

(3)

3.2.2 **OPTION 1/OPSIE 1**

UPWARDS AS POSITIVE OPWAARTS AS POSITIEF $v_f = v_i + a\Delta t \checkmark$ $= (10) + (-9,8)(3) \checkmark$ $= -19,40 \text{ m}\cdot\text{s}^{-1} \checkmark$ Speed = $19,40 \text{ m}\cdot\text{s}^{-1} \checkmark$ <i>Spood = 19,40 m·s⁻¹</i>	DOWNWARDS AS POSITIVE AFWAARTS AS POSITIEF $v_f = v_i + a\Delta t \checkmark$ $= (-10) + (9,8)(3) \checkmark$ $= 19,40 \text{ m}\cdot\text{s}^{-1} \checkmark$ Speed = $19,40 \text{ m}\cdot\text{s}^{-1} \checkmark$ <i>Spood = 19,40 m·s⁻¹</i>
OPTION 2/OPSIE 2 UPWARDS AS POSITIVE OPWAARTS AS POSITIEF $v_f^2 = v_i^2 + 2a\Delta x \checkmark$ $= (-10)^2 + 2(-9,8)(-14,1) \checkmark$ $v_f = 19,4 \text{ m}\cdot\text{s}^{-1} \checkmark$	DOWNWARDS AS POSITIVE AFWAARTS AS POSITIEF $v_f^2 = v_i^2 + 2a\Delta x \checkmark$ $= (10)^2 + 2(9,8)(14,1) \checkmark$ $v_f = 19,4 \text{ m}\cdot\text{s}^{-1} \checkmark$

POSITIVE MARKING FROM QUESTION 3.2.1**POSITIEWE NASIEN VANAF VRAAG 3.2.1****OPTION 3/OPSIE 3**

UPWARDS AS POSITIVE OPWAARTS AS POSITIEF $\Delta y = \frac{v_i + v_f}{2} \Delta t \checkmark$ $-14,12 = \frac{(10 + v_f)}{2} \cdot 3 \checkmark$ $v_f = 19,41 \text{ m}\cdot\text{s}^{-1} \checkmark$ Speed = $19,41 \text{ m}\cdot\text{s}^{-1} \checkmark$ <i>Spood = 19,41 m·s⁻¹</i>	DOWNWARDS AS POSITIVE AFWAARTS AS POSITIEF $\Delta y = \frac{v_i + v_f}{2} \Delta t \checkmark$ $+14,12 = \frac{(-10 + v_f)}{2} \cdot 3 \checkmark$ $v_f = 19,41 \text{ m}\cdot\text{s}^{-1} \checkmark$ Speed = $19,41 \text{ m}\cdot\text{s}^{-1} \checkmark$ <i>Spood = 19,41 m·s⁻¹</i>
--	---

(3)

3.2.3

OPTION 1/OPSIE 1 UPWARDS AS POSITIVE OPWAARTS AS POSITIEF $v_f^2 = v_i^2 + 2a\Delta y \checkmark$ $0 = v_i^2 + (2)(-9,8)(8) \checkmark$ $v_i = 12,52 \text{ m}\cdot\text{s}^{-1} \checkmark$ Speed = $12,52 \text{ m}\cdot\text{s}^{-1} \checkmark$ <i>Spood = 12,52 m·s⁻¹</i>	DOWNWARDS AS POSITIVE AFWAARTS AS POSITIEF $v_f^2 = v_i^2 + 2a\Delta y \checkmark$ $0 = v_i^2 + (2)(9,8)(-8) \checkmark$ $v_i = -12,52 \text{ m}\cdot\text{s}^{-1} \checkmark$ Speed = $12,52 \text{ m}\cdot\text{s}^{-1} \checkmark$ <i>Spood = 12,52 m·s⁻¹</i>
OPTION 2/OPSIE 2 UPWARDS AS POSITIVE OPWAARTS AS POSITIEF $\Delta x = v_i\Delta t + \frac{1}{2}a\Delta t^2$ $-8 = 0 + \frac{1}{2}(-9,8)\Delta t^2$ $\Delta t = 1,28 \text{ s}$ $v_f = v_i + a\Delta t \checkmark$ $0 = v_i + (-9,8)(1,28) \checkmark$ $v_i = 12,52 \text{ m}\cdot\text{s}^{-1} \checkmark$ Speed = $12,52 \text{ m}\cdot\text{s}^{-1} \checkmark$ <i>Spood = 12,52 m·s⁻¹</i>	DOWNWARDS AS POSITIVE AFWAARTS AS POSITIEF $\Delta x = v_i\Delta t + \frac{1}{2}a\Delta t^2$ $8 = 0 + \frac{1}{2}(9,8)\Delta t^2$ $\Delta t = 1,28 \text{ s}$ $v_f = v_i + a\Delta t \checkmark$ $0 = v_i + (9,8)(1,28) \checkmark$ $v_i = -12,52 \text{ m}\cdot\text{s}^{-1} \checkmark$ Speed = $12,52 \text{ m}\cdot\text{s}^{-1} \checkmark$ <i>Spood = 12,52 m·s⁻¹</i>

(3)

3.3 UPWARDS AS POSITIVE/OPWAARTS AS POSITIEF

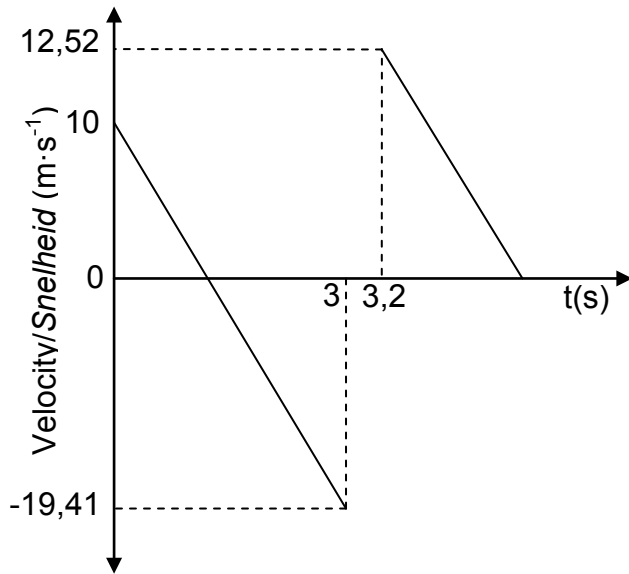

CHECKLIST FOR MARKING RIGLYNE VIR NASIEN	
Each line correctly drawn with calculated velocities. 1 x 2 <i>Elke lyn korrek geteken met berekende waardes 1 x 2</i>	✓✓
Mark for lines being parallel <i>Twee parallelle lyne korrek geteken</i>	✓
Times 3 s and 3,2 s correctly shown <i>Tye 3 s en 3,2 s korrek getoon</i>	✓

3.3 DOWNWARDS AS POSITIVE/AFWAARTS AS POSITIEF

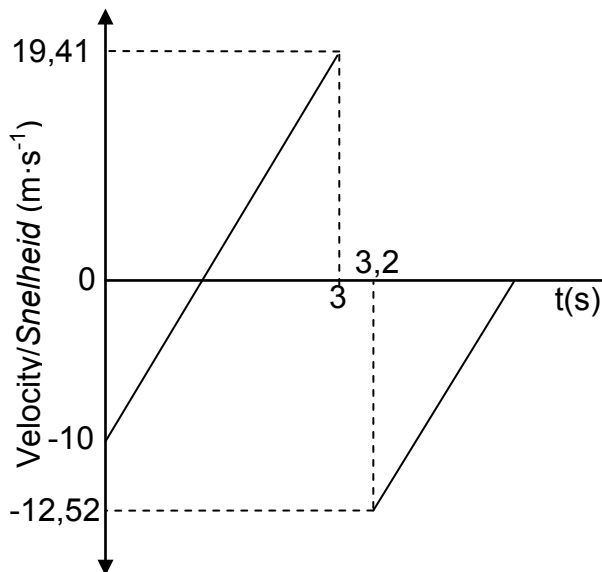

CHECKLIST FOR MARKING RIGLYNE VIR NASIEN	
Each line correctly drawn with calculated velocities. 1 x 2 <i>Elke lyn korrek geteken met berekende waardes 1 x 2</i>	✓✓
Mark for lines being parallel <i>Twee parallelle lyne korrek geteken</i>	✓
Times 3 s and 3,2 s correctly shown <i>Tye 3 s en 3,2 s korrek getoon</i>	✓

(4)
[15]

QUESTION/VRAAG 4

4.1	<u>OPTION 1/OPSIE 1</u>	<u>OPTION 2/OPSIE 2</u>	<u>OPTION 2/OPSIE 2</u>
	$v = \frac{\Delta x}{\Delta t}$	$v = \frac{\Delta x}{\Delta t}$	$v = \frac{\Delta x}{\Delta t}$
	$= \frac{0,2}{0,4}$	$= \frac{0,4}{0,8}$	$= \frac{0,6}{1,2}$
	$= 0,5 \text{ m}\cdot\text{s}^{-1}$	$= 0,5 \text{ m}\cdot\text{s}^{-1}$	$= 0,5 \text{ m}\cdot\text{s}^{-1}$

- ✓ Formula/Formule
- ✓ Correct substitution in all three equations/Korrekte vervanging in al drie vergelykings
- ✓ Correct answer/korrekte antwoord
 - If only two calculations used with correct answer, award 2/3
Indien slegs twee berekenings met korrekte antwoord gebruik word, ken 2/3 toe
 - If unit(s) omitted lose 1 mark./Indien eenhede weggelaat is verbeur 1 punt

OPTION 2/OPSIE 2

Trolley moves with equal displacements in equal time (intervals). (Full marks or zero)

Trollie beweeg met gelyke verplasinge in gelyke tydintervalle (Vol punte of nul)

(3)

4.2 The total linear momentum of a closed (isolated) system remains constant (is conserved).

Die totale lineêre momentum in 'n geslote (geïsoleerde) sisteem bly konstant (is behoue).

OR/OF

In an isolated system, the total linear momentum before collision is equal to the total linear momentum after collision

In 'n geslote (geïsoleerde) sisteem is die totale lineêre momentum voor botsing gelyk aan die totale lineêre momentum na botsing.

(2)

NOTE:/LET WEL

If the words “closed (isolated)” or “total” omitted, award 1/2.

Indien die woorde “geslote (geïsoleerde)” of totaal weggelaat is, ken 1/2 toe

4.3 POSITIVE MARKING FROM QUESTION 4.1/POSITIEWE NASIEN VANAF VRAAG 4.1

<p>OPTION 1/OPSIE 1</p> $\Sigma p_i = \Sigma p_f$ $m_1 v_{1i} + m_2 v_{2i} = m_1 v_{1f} + m_2 v_{2f}$ <div style="border: 1px solid black; padding: 2px; display: inline-block; margin-left: 100px;">✓ Any one/Enige een</div>	
$(3,5)(0,5) \checkmark = (3,5 + 6)v_f \checkmark$ $v_f = v_{6\text{kg}}$ $= 0,184 \text{ m}\cdot\text{s}^{-1}$	
<p>For trolley B:/Vir trollie B:</p> $F_{\text{net}}\Delta t = \Delta p = m\Delta v \checkmark$ $F_{\text{net}}(0,5) = 6(0,184 - 0) \checkmark$ $F_{\text{net}} = 2,21 \text{ N (2,24 N)} \checkmark$	<div style="border: 1px solid black; padding: 5px;"> $F_{\text{net}} = ma$ $m \frac{(v_f - v_i)}{\Delta t} = (6) \frac{(0,184 - 0)}{0,05}$ $= 2,21 \text{ N}$ </div>
<p>OPTION 2/OPSIE 2</p> $\Sigma p_i = \Sigma p_f$ $m_1 v_{1i} + m_2 v_{2i} = m_1 v_{1f} + m_2 v_{2f}$ <div style="border: 1px solid black; padding: 2px; display: inline-block; margin-left: 100px;">✓ Any one/Enige een</div>	
$(3,5)(0,5) \checkmark = (3,5 + 6)v_f \checkmark$ $v_f = v_{6\text{kg}}$ $= 0,184 \text{ m}\cdot\text{s}^{-1}$	
<p>For trolley B:/Trollie B:</p> $F_{\text{net}}\Delta t = \Delta p = m\Delta v \checkmark$ $F_{\text{net}}(0,5) = 6(0,184 - 0) \checkmark$ $F_{\text{net}} = 2,21 \text{ N (2,24 N)} \checkmark$	<p>For trolley A:/Trollie A:</p> $F_{\text{net}}\Delta t = \Delta p = m\Delta v \checkmark$ $F_{\text{net}}(0,5) = 3,5(0,184 - 0,5) \checkmark$ $F_{\text{net}} = -2,21 \text{ N (2,24 N)}$ <p>∴ Magnitude of the average net force experienced by trolley B = 2,21 N (2,24 N) ✓</p> <p>∴ Grootte van die gemiddelde netto krag deur trollie B ondervind = 2,21 N (2,24 N)</p>

(6)
[11]

<p>OPTION 3/OPSIE 3</p> $\Sigma p_i = \Sigma p_f$ $m_1 v_{1i} + m_2 v_{2i} = m_1 v_{1f} + m_2 v_{2f}$		<div style="border: 1px solid black; padding: 5px; display: inline-block;"> ✓ Any one/Enige een </div>
$(3,5)(0,5) \checkmark = (3,5 + 6)v_{f_} \checkmark$ $v_f = v_{6\text{kg}}$ $= 0,184 \text{ m}\cdot\text{s}^{-1}$		
<p><u>For trolley B:/Trollie B:</u></p> $v_f = v_i + a\Delta t$ $0,184 = 0 + a(0,5)$ $a = 0,368 \text{ ms}^{-1}$ $F_{\text{net}} = ma \checkmark$ $= (6)(0,368)$ $= 2,21 \text{ N}$	<p><u>For trolley A:/Trollie A:</u></p> $v_f = v_i + a\Delta t$ $0,184 = 0,5 + a(0,5)$ $a = -0,632 \text{ ms}^{-1}$ $F_{\text{net}} = ma \checkmark$ $= (3,5)(-0,632)$ $= -2,21 \text{ N}$ <p>∴ Magnitude of the average net force experienced by trolley B = 2,21 N (2,24 N) ✓</p> <p>∴ Grootte van die gemiddelde netto krag deur trollie B ondervind = 2,21 N (2,24 N)</p>	

(6)
[11]

QUESTION/VRAAG 5

5.1

ACCEPT/AANVAAR

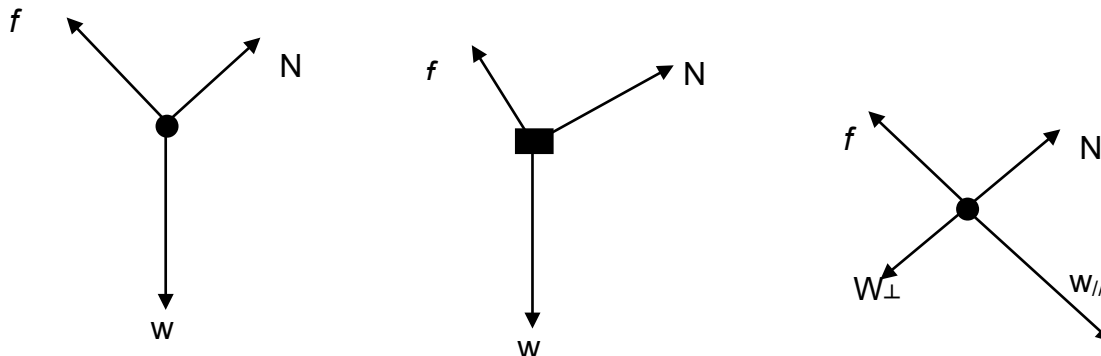

Accepted labels/Aanvaarde benoemings		
w	F_g/F_w /weight/mg/gravitational force F_g/F_w /gewig/mg/gravitasiekrag	✓
f	Friction/ F_f /50 N/wrywing/ F_w	✓
N	Normal force/ F_{NORMAL} / F_{NOR} / $F_{NORMAAL}$	✓

Notes/Aantekeninge

- Mark awarded for label and arrow/Punt toegeken vir benoeming en pyltjie
- Deduct 1 mark if arrow(s) is (are) missing/ Trek 1 punt af indien pylpunt(e) nie aangeheg is nie
- Do not penalise for length of arrows since drawing is not to scale./Moenie vir die lengte van die pyltjies penaliseer nie aangesien die tekening nie volgens skaal is nie Any other additional force(s)/Enige ander addisionele krag(te) Max/Maks 2
- If force(s) do not make contact with body/Indien krag(te) nie met die voorwerp kontak maak nie: Max/Maks: $\frac{3}{4}$
- Award 1 mark if both resolved components of w are correct/Ken 1 punt toe indien beide komponente van w korrek is.

- 5.2 The net/total work done on an object equals the change in the object's kinetic energy. ✓✓
Die netto/totale arbeid op 'n voorwerp verrig is gelyk aan die verandering in die voorwerp se kinetiese energie

OR/OF

- The work done by the net force equals the change in the object's kinetic energy. ✓✓
Die arbeid verrig deur die netto krag is gelyk aan die voorwerp se verandering in kinetiese energie.

(2)

5.3

OPTION 1/OPSIE 1

$$W_{\text{net}} = \Delta E_K$$

$$f\Delta x \cos\theta + F_g \Delta x \cos\theta = \frac{1}{2}mv_f^2 - \frac{1}{2}mv_i^2$$

✓ Any one/Enige een

$$(50)(25\cos 180^\circ) \checkmark + (60)(9,8)(25\cos 70^\circ) \checkmark = \frac{1}{2}(60)(15^2 - v_i^2) \checkmark$$

$$-1\,250 + 5\,027,696 = 6\,750 - 30v_i^2$$

$$v_i = 9,95(4) \text{ m}\cdot\text{s}^{-1} \checkmark$$

OPTION 2/OPSIE 2

$$W_{\text{net}} = \Delta E_K$$

$$f\Delta x \cos\theta + F_{g\parallel} \Delta x \cos\theta = \frac{1}{2}mv_f^2 - \frac{1}{2}mv_i^2$$

✓ Any one/Enige een

$$(50)(25\cos 180^\circ) \checkmark + (60)(9,8\sin 20^\circ)(25\cos 0^\circ) \checkmark = \frac{1}{2}(60)(15^2 - v_i^2) \checkmark$$

$$-1\,250 + 5\,027,696 = 6\,750 - 30v_i^2$$

$$v_i = 9,95(4) \text{ m}\cdot\text{s}^{-1} \checkmark$$

OPTION 3/OPSIE 3

$$W_{\text{nc}} = \Delta E_K + \Delta E_P$$

$$f\Delta x \cos\theta = \frac{1}{2}(mv_f^2 - mv_i^2) + (mgh_Q - mgh_P)$$

$$E_{\text{mechP}} + E_{\text{mechQ}} + W_{\text{nc}} = 0$$

✓ Any one/Enige een

$$(50)(25\cos 180^\circ) \checkmark = \frac{1}{2}(60)(15^2 - v_i^2) \checkmark + (60)(9,8)(-25\sin 20^\circ) \checkmark$$

$$-1\,250 = 6\,750 - 30v_i^2 - 5\,027,696$$

$$v_i = 9,95 \text{ m}\cdot\text{s}^{-1} \checkmark$$

(5)

OPTION 4/OPSIE 4

$$F_{\text{net}} = 201,11 - 50$$

$$= 151,11 \text{ N}$$

$$W_{\text{net}} = \Delta E_K \checkmark$$

$$F_{\text{net}} \Delta x \cos\theta = \frac{1}{2}(mv_f^2 - mv_i^2)$$

$$(151,11)(25)\cos 0^\circ \checkmark = \frac{1}{2}(15^2 - v_i^2) \checkmark$$

$$v_i = 9,95 \text{ m}\cdot\text{s}^{-1} \checkmark$$

5.4

POSITIVE MARKING FROM QUESTION 5.3
POSITIEWE NASIEN VANAF VRAAG 5.3

OPTION 1/OPSIE 1

$$P_{\text{ave/gemid}} = F v_{\text{ave/gemid}} \checkmark$$

$$= 50 \checkmark \frac{(9,95 + 15)}{2} \checkmark$$

$$= 623,75 \text{ W} \checkmark$$

OPTION 2/OPSIE 2

$$P = \frac{W}{\Delta t}$$

$$P_f = \frac{f \Delta x \cos \theta}{\Delta t}$$

$$= \frac{[50(25 \cos 180^\circ)]}{2,004} \checkmark$$

$$= -623,75 \text{ W} \text{ (- 625 W)}$$

$$P_{\text{boy/seun}} = 623,75 \text{ W} \text{ (625 W)} \checkmark$$

\checkmark Any one/Enige een

$$\Delta x = \frac{(v_i + v_f)}{2} \Delta t$$

$$25 = \frac{(9,95 + 15)}{2} \Delta t \checkmark$$

$$\Delta t = 2,004 \text{ s}$$

$P_{\text{boy/seun}} = \frac{F \Delta x \cos \theta}{\Delta t} \checkmark$

$$= \frac{[50(25 \cos 0^\circ)]}{2,004} \checkmark$$

$$= 623,75 \text{ W} \checkmark$$

NOTE/LET WEL:

Candidates can substitute -1 250 from QUESTION 5.3 directly into the equation

Kandidate kan – 1 250 vanaf VRAAG 5.3 direk in die vergelyking vervang

(4)
[14]

QUESTION/VRAAG 6

6.1

- 6.1.1 It is the change in frequency (or pitch)✓ of the sound detected by a listener because the sound source and the listener have different velocities relative to the medium ✓of sound propagation.

OR/OF

An apparent change in frequency (pitch), (wavelength) ✓as a result of the relative motion between a source and an observer ✓(listener).

Die skynbare verandering in frekwensie (toonhoogte) as gevolg van die relatiewe beweging tussen die bron en die waarnemer.

(2)

6.1.2

$$f_L = \frac{v \pm v_L}{v \pm v_s} f_s \quad \text{OR/OF} \quad f_L = \frac{v}{v - v_s} f_s \quad \checkmark$$

$$365 = \frac{(340 + 0)}{(340 - v_s)} \checkmark \times 330 \quad \checkmark$$

$$v_s = 32,60 \text{ m} \cdot \text{s}^{-1} \quad \checkmark$$

(5)

6.2

According to the Doppler Effect if the star moves away ✓from the observer a lower frequency/longer wavelength ✓is detected. This lower frequency/longer wavelength corresponds to the red end of the spectrum ✓

Volgens die Doppler-effek as die ster weg vanaf die waarnemer beweeg word 'n laer frekwensie/ langer golflengte waargeneem. Hierdie laer frekwensie/ langer golflengte stem ooreen met die rooi ent van die spektrum.

(3)

[10]**QUESTION/VRAAG 7**

7.1

The magnitude of the electrostatic force exerted by one point charge (Q_1) on another point charge (Q_2) is directly proportional to the product of the (magnitudes of the) charges ✓ and inversely proportional to the square of the distance (r) between them. ✓

Die grootte van die elektrostatiese krag uitgeoefen deur een punt lading (Q_1) op 'n ander puntlading (Q_2) is direk eweredig aan die produk van die (groottes van die) ladings en omgekeerd eweredig aan die kwadraat van die afstand (r) tussen hulle.

(2)

7.2.1 Negative/Negatief ✓✓

(2)

7.2.2 $F = k \frac{Q_1 Q_3}{r^2}$ ✓ (Accept/Aanvaar $F = k \frac{Q_1 Q_2}{d^2}$)

$$0,012 = \frac{(9 \times 10^9) Q_1 (2 \times 10^{-6})}{(2,5)^2}$$
 ✓

$$Q_1 = 4,17 \times 10^{-6} \text{ C}$$
 ✓

$$F_{\text{net}} = F_{Q_{13}} + F_{Q_{23}}$$
 ✓

$$-0,3 = 0,012 - \frac{(9 \times 10^9)(Q_2)(2 \times 10^{-6})}{1^2}$$
 ✓✓

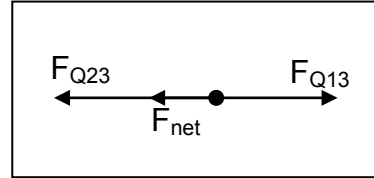
**OR/OF**

$$0,3 = -0,012 + \frac{(9 \times 10^9)(Q_2)(2 \times 10^{-6})}{1^2}$$
 ✓✓

$$Q_2 = 1,73 \times 10^{-5} \text{ C}$$
 ✓

Do not penalise for the nature of the charges.
 Moenie vir die aard van die ladings penaliseer nie.

(7)
[11]

QUESTION/VRAAG 8

8.1 Electric field is a region of space in which an electric charge experiences a force. ✓✓

Elektriese veld is 'n gebied in die ruimte waarin 'n elektriese lading 'n krag ondervind.

(2)

8.2

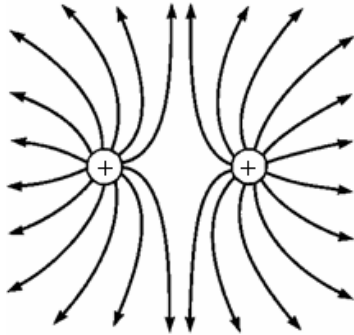

Criteria for sketch/Kriteria vir skets	Marks/Punte
Correct shape as shown. <i>Korrekte vorm soos getoon.</i>	✓
Direction away from positive <i>Rigting weg van positief .</i>	✓
Field lines start on spheres and do not cross for correct diagram. <i>Veldlyne begin op elke sfeer en kruis nie.</i>	✓

(3)

8.3

$$\begin{aligned}
 E_{PA} &= \frac{kQ}{r^2} \checkmark \\
 &= \frac{(9 \times 10^9)(5 \times 10^{-6})}{(1,25)^2} \checkmark \\
 &= 2,88 \times 10^4 \text{ N} \cdot \text{C}^{-1} \text{ to the right/na regs}
 \end{aligned}$$

$$\begin{aligned}
 E_{PB} &= \frac{kQ}{r^2} \\
 &= \frac{(9 \times 10^9)(5 \times 10^{-6})}{(0,75)^2} \checkmark \\
 &= 8,00 \times 10^4 \text{ N} \cdot \text{C}^{-1} \text{ to the left/na links}
 \end{aligned}$$

$$\begin{aligned}
 E_{\text{net}} &= E_{PA} + E_{PB} \\
 &= 2,88 \times 10^4 + (-8,00 \times 10^4) \\
 &= 5,12 \times 10^4 \text{ N} \cdot \text{C}^{-1} \checkmark
 \end{aligned}$$

✓ Vector addition/Vektoroptelling

(5)
[10]

QUESTION/VRAAG 9

- 9.1.1 The potential difference across a conductor is directly proportional to the current in the conductor at constant temperature ✓✓

Die potensiaalverskil oor 'n geleier is direk eweredig aan die stroom deur die geleier by konstante temperatuur.

NOTE/LET WEL

If constant temperature is omitted -1 mark

Indien konstante temperatuur weggelaat word -1 punt

(2)

- 9.1.2

Graph of potential difference versus current
Grafiek van potensiaalverskil teenoor stroom

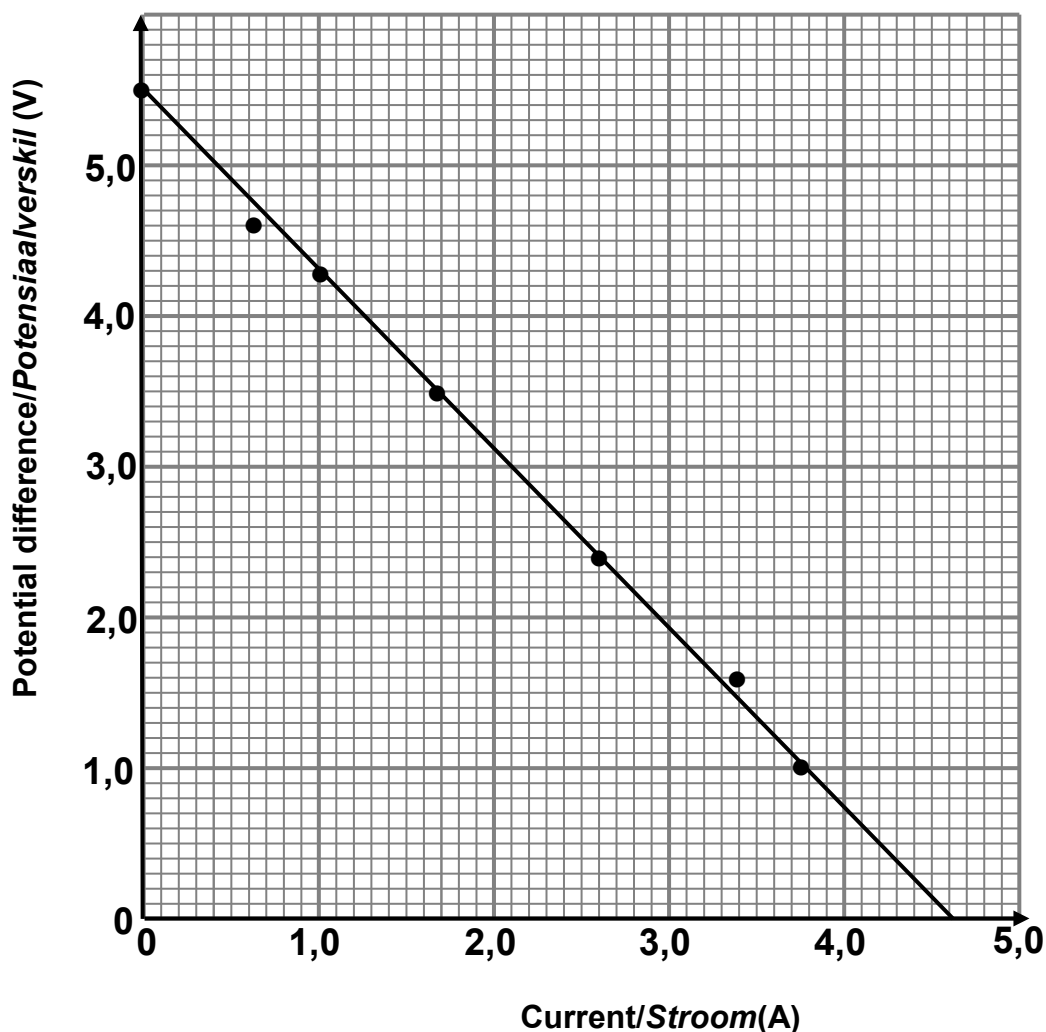

Straight line passing through 4 or five points ✓.

Straight line with intercepts on both axes ✓.

Reguitlyn deur 4 of 5 punte

Reguitlyn met afsnitte op beide asse

(2)

- 9.1.3 5,5 V (accept any value from /aanvaar enige waarde vanaf 5,4 V to/tot 5,6 V based on graph drawn/op die grafiek gebaseer.)

NOTE /LET WEL :

The value must be the y-intercept./ Die waarde moet die y-afsnit wees.

(1)

9.1.4

$$\text{Slope/helling} = \frac{\Delta V}{\Delta I} \text{ or/of } \frac{y_2 - y_1}{x_2 - x_1}$$

$$= \frac{5,5-0}{0-4,6} = -1,2$$

Internal resistance/*Interne weerstand* (r) = 1,2 Ω ✓**NOTE/LET WEL:**

Any correct pair of coordinates chosen from the line drawn

*Enige korrekte paar koördinate vanaf die getekende lyne gekies*For the equation $\varepsilon = I(R + r)$ or $\varepsilon = V_{\text{ext}} + Ir$ marks are awarded only if the correct I and V values are used from the graph*Vir die vergelyking $\varepsilon = I(R + r)$ of $\varepsilon = V_{\text{ext}} + Ir$ sal punte slegs toegeken word indien die korrekte waardes van I and V vanaf die grafiek gebruik is.*

(3)

9.2.1

$$\left. \begin{array}{l} R = \frac{V}{I} \\ I = \frac{V}{R} \\ V = IR \end{array} \right\}$$

✓ any of these/*enige van hierdie*

21,84 = I_{tot} (8) ✓

$I_{\text{tot}} = 2,73 \text{ A}$ ✓

(3)

9.2.2

OPTION 1/OPSIE 1

$$\frac{1}{R_{\parallel}} = \frac{1}{R_{30}} + \frac{1}{R_{20}}$$

$$\frac{1}{R_{\parallel}} = \frac{1}{30} + \frac{1}{20} \checkmark$$

$R_{\parallel} = 12 \Omega$ ✓

$$R_{\parallel} = \frac{R_{30} \times R_{20}}{R_{30} + R_{20}}$$

$$R_{\parallel} = \frac{30 \times 20}{50} \checkmark$$

$$= 12 \Omega \checkmark$$

(2)

9.2.3

POSITIVE MARKING FROM QUESTION 9.2.1 AND 9.2.2
POSITIEWE NASIEN VANAF VRAAG 9.2.1 EN 9.2.2**OPTION 1/OPSIE 1**

$$R_{\text{tot}} = (8 + 12 + r) \quad (\text{for the addition/vir optelling})$$

$$= (20 + r)$$

$\varepsilon = I(R + r)$ ✓

60 ✓ = (2,73)(20 + r) ✓

$\therefore r = 1,98 \Omega$ ✓

POSITIVE MARKING FROM QUESTION 9.2.1**POSITIEWE NASIEN VANAF VRAAG 9.2.1****OPTION 2/OPSIE 2**

$$V_{||} = I_{\text{tot}} R_{||}$$

$$= (2,73)(12) \checkmark$$

$$= 32,76 \text{ V}$$

$$\therefore V_{\text{terminal}} = (32,76 + 21,84) \checkmark \text{ for addition/vir optelling}$$

$$= 54,6 \text{ V}$$

$$"V_{\text{lost}}" = 60 - 54,6 = 5,4 \text{ V}$$

$$R = \frac{V}{I}$$

$$I = \frac{V}{R}$$

$$V = IR$$

✓ any of these/enige van hierdie

$$\mathcal{E} = V_{\text{lost}} + V_{||} + V_8$$

$$60 = (V_{\text{lost}} + 32,76 + 21,84) \checkmark$$

$$V_{\text{lost}} = 5,4 \text{ V}$$

$$5,4 = 2,73 r$$

$$r = 1,98 \Omega \checkmark$$

NOTE/LET WEL:

No penalisation for omitted subscripts

Geen penalisering vir weggelate onderskrifte nie

(4)

9.2.4

POSITIVE MARKING FROM 9.2.1 AND 9.2.2**POSITIEWE NASIEN VANAF VRAAG 9.2.1 EN 9.2.2****OPTION 1/OPSIE 1**

$$W = \frac{V^2}{R} \Delta t \checkmark$$

$$W = \frac{(54,6)^2}{20} (0,2) \checkmark$$

$$= 29,81 \text{ J} \checkmark$$

OPTION 2/OPSIE 2

$$W = I^2 R \Delta t \checkmark$$

$$= (2,73)^2 (20)(0,2) \checkmark$$

$$= 29,81 \text{ J} \checkmark$$

OPTION 3/OPSIE 3

$$W = VI \Delta t \checkmark$$

$$= (54,6)(2,73)(0,2) \checkmark$$

$$= 29,81 \text{ J} \checkmark$$

(3)
[20]

QUESTION/VRAAG10

- 10.1.1 **R:** armature/Coil(s)/Spoel✓
T: (Carbon/Koolstof) brushes/borsels✓
X: Slip rings/sleepringe✓

NOTE/LETWEL:

Answers must be in that order if R, T and X are omitted.

Antwoorde moet in hierdie orde wees as R, T en X weggelaat

(3)

- 10.1.2 Faraday's Law/Faraday se wet ✓

(1)

- 10.2.1 15 V✓

(1)

- 10.2.2

OPTION 1/OPSIE 1

$$V_{rms} = I_{rms} R$$

$$I_{rms} = \frac{15}{45} \checkmark$$

$$= 0,333 \text{ A}$$

$$I_{rms} = \frac{I_{max}}{\sqrt{2}}$$

$$I_{max} = (0,333) \sqrt{2} \checkmark$$

$$= 0,47 \text{ A} \checkmark$$

✓ any one/enige een

OPTION 2/OPSIE 2

$$V_{rms} = \frac{V_{max}}{\sqrt{2}}$$

$$V_{max} = (15) \sqrt{2} \checkmark$$

$$= 21,213 \text{ V}$$

$$V_{max} = I_{max} R$$

$$21,213 \checkmark$$

$$I_{max} = \frac{45}{\quad}$$

$$= 0,47 \text{ A} \checkmark$$

✓ any one/enige een

OPTION 3/OPSIE 3

$$I_{max} = I_{rms} \sqrt{2}$$

$$= \sqrt{2} \frac{V_{rms}}{R}$$

$$= \sqrt{2} \frac{V_{rms}}{R}$$

$$= \sqrt{2} \frac{15}{45} \checkmark \checkmark$$

$$= 0,47 \text{ A} \checkmark$$

✓ any one/enige een

OPTION 4/OPSIE 4

$$P_{\text{ave}} = \frac{V_{\text{rms}}^2}{R} = \frac{15^2}{45} = 5 \text{ W}$$

$$P_{\text{ave}} = V_{\text{rms}} I_{\text{rms}}$$

$$5 = (15) I_{\text{rms}} \checkmark$$

$$I_{\text{rms}} = 0,33 \text{ A}$$

$$I_{\text{rms}} = \frac{I_{\text{max}}}{\sqrt{2}}$$

$$0,33 = \frac{I_{\text{max}}}{\sqrt{2}} \checkmark$$

$$I_{\text{max}} = 0,47 \text{ A} \checkmark$$

✓ any one/enige een

(4)
[9]

QUESTION/VRAAG 11

11.1 It is the process whereby electrons are ejected from a (metal) surface when light of suitable frequency is incident on that surface. ✓✓

Dit is die proses waarby elektrone vanaf die oppervlak van 'n metaal vrygestel word wanneer lig van geskikte frekwensie daarop skyn.

(2)

11.2 INCREASE / TOENEEM ✓

– Increase in intensity means that (for the same frequency) the number of photons incident per unit time increase. ✓ Therefore the number of electrons ejected per unit time increases. ✓

Thus current increases.

Toename in intensiteit beteken dat (vir dieselfde frekwensie) die aantal fotone per eenheid tyd neem toe. Dus sal die aantal elektrone per eenheid tyd vrygestel, toeneem.

(3)

11.3

OPTION 1/OPSIE 1

$$E = W_0 + E_{k(\text{max})}$$

$$hf = hf_0 + E_{k(\text{max})}$$

$$hf = hf_0 + \frac{1}{2} mv^2$$

$$E = W_0 + \frac{1}{2} mv^2$$

✓ Any one/Enige een

$$(6,63 \times 10^{-34} \times 5,9 \times 10^{14}) \checkmark = \frac{(6,63 \times 10^{-34})(3 \times 10^8) \checkmark}{\lambda_0} + 2,9 \times 10^{-19} \checkmark$$

$$39,117 \times 10^{-20} - 2,9 \times 10^{-19} = \frac{19,89 \times 10^{-26}}{\lambda_0}$$

$$\lambda_0 = 1,97 \times 10^{-6} \text{ m} \checkmark$$

OPTION 2/OPSIE 2

$$\left. \begin{aligned} E &= W_o + E_{k(\max)} \\ hf &= hf_o + E_{k(\max)} \\ hf &= hf_o + \frac{1}{2} mv^2 \\ E &= W_o + \frac{1}{2} mv^2 \end{aligned} \right\} \checkmark \text{Any one/Enige een}$$

$$(6,63 \times 10^{-34} \times 5,9 \times 10^{14}) \checkmark = (6,63 \times 10^{-34})f_o + 2,9 \times 10^{-19} \checkmark$$

$$f_o = 1,52 \times 10^{14} \text{ Hz}$$

$$c = f_o \lambda_o$$

$$3 \times 10^8 = (1,52 \times 10^{14}) \lambda_o \checkmark$$

$$\lambda_o = 1,97 \times 10^{-6} \text{ m} \checkmark$$

(5)

OPTION 3/OPSIE 3

$$\left. \begin{aligned} E &= W_o + E_{k(\max)} \\ hf &= hf_o + E_{k(\max)} \\ hf &= hf_o + \frac{1}{2} mv^2 \\ E &= W_o + \frac{1}{2} mv^2 \end{aligned} \right\} \checkmark \text{Any one/Enige een}$$

$$(6,63 \times 10^{-34} \times 5,9 \times 10^{14}) \checkmark = W_o + 2,9 \times 10^{-19} \checkmark$$

$$W_o = 1,01 \times 10^{-19} \text{ J}$$

$$W_o = hf_o$$

$$1,01 \times 10^{-19} = (6,63 \times 10^{-34})f_o$$

$$f_o = 1,52 \times 10^{14} \text{ Hz}$$

$$c = f_o \lambda_o$$

$$3 \times 10^8 = (1,52 \times 10^{14}) \lambda_o \checkmark$$

$$\lambda_o = 1,97 \times 10^{-6} \text{ m} \checkmark$$

- 11.4 From the photo-electric equation, for a constant work function, ✓ the maximum kinetic energy of the photoelectrons is proportional to the energy of the photons.✓

Vanaf die foto-elektriese vergelyking is die maksimum kinetiese energie van die foto-elektrone eweredig aan die energie van die fotone vir 'n konstante arbeidsfunksie.

(2)
[12]