



basic education

Department:
Basic Education
REPUBLIC OF SOUTH AFRICA

**NATIONAL
SENIOR CERTIFICATE**

GRADE 12

LIFE SCIENCES P1

NOVEMBER 2021

MARKS: 150

TIME: 2½ hours

This question paper consists of 16 pages.

INSTRUCTIONS AND INFORMATION

Read the following instructions carefully before answering the questions.

1. Answer ALL the questions.
2. Write ALL the answers in the ANSWER BOOK.
3. Start the answers to EACH question at the top of a NEW page.
4. Number the answers correctly according to the numbering system used in this question paper.
5. Present your answers according to the instructions of each question.
6. Do ALL drawings in pencil and label them in blue or black ink.
7. Draw diagrams, tables or flow charts only when asked to do so.
8. The diagrams in this question paper are NOT necessarily drawn to scale.
9. Do NOT use graph paper.
10. You must use a non-programmable calculator, protractor and a compass, where necessary.
11. Write neatly and legibly.

SECTION A**QUESTION 1**

1.1 Various options are provided as possible answers to the following questions. Choose the answer and write only the letter (A to D) next to the question numbers (1.1.1 to 1.1.9) in the ANSWER BOOK, e.g. 1.1.10 D.

- 1.1.1 Grommets are used in the treatment of ...
- A deafness.
 - B blindness.
 - C middle-ear infection.
 - D multiple sclerosis.
- 1.1.2 The ability of the lens of the eye to change its shape when viewing an object that is near or far is called ...
- A binocular vision.
 - B accommodation.
 - C pupillary mechanism.
 - D refraction of light rays.
- 1.1.3 Which ONE of the following is the visual defect that results from the uneven curvature of the cornea?
- A Cataracts
 - B Long-sightedness
 - C Short-sightedness
 - D Astigmatism
- 1.1.4 The receptor(s) involved in maintaining balance is/are the ...
- A organ of Corti only.
 - B maculae only.
 - C maculae and cristae only.
 - D organ of Corti, maculae and cristae.
- 1.1.5 Which of the following structures are involved in maintaining balance when there is a change in the direction of movement of the body?
- A Semi-circular canals and cerebellum
 - B Eustachian tube and cerebellum
 - C Semi-circular canals and cerebrum
 - D Eustachian tube and cerebrum

1.1.6 Which of the following structures are protected by the meninges?

- A Spinal cord and receptors
- B Spinal cord and brain
- C Brain and effectors
- D Effectors and receptors

1.1.7 Two men were given a glucose-rich meal at the same time (0 hours). One man is diabetic and the other is non-diabetic. The diabetic did not receive any medical treatment. Their blood glucose levels were measured over a period of 3 hours.

The graphs below show the possible blood glucose levels of the two men during this time.

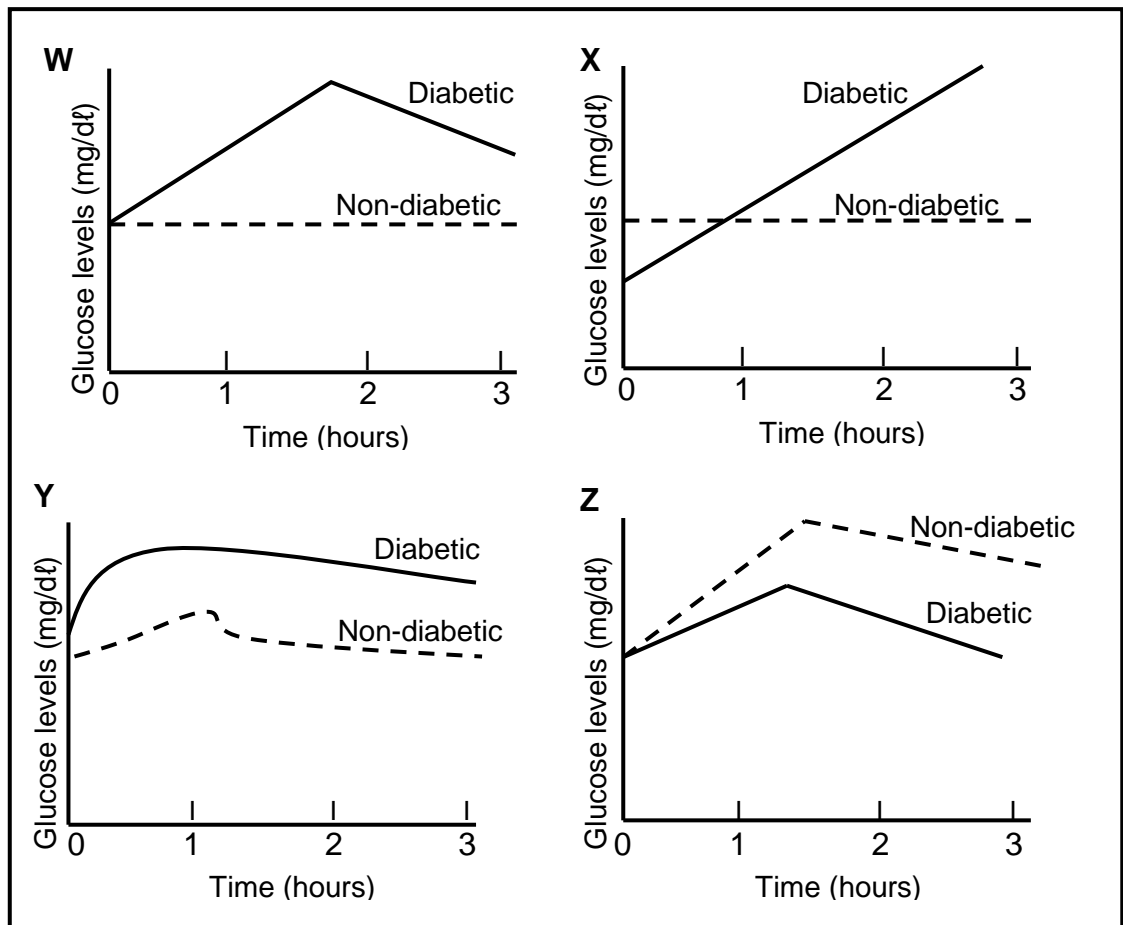

Which ONE of the graphs correctly represents the blood glucose levels of the two men?

- A W
- B X
- C Y
- D Z

1.1.8 During a reflex action, impulses enter the spinal cord by means of a/an ...

- A sensory neuron through the ventral root of the spinal nerve.
- B sensory neuron through the dorsal root of the spinal nerve.
- C interneuron through the ventral root of the spinal nerve.
- D interneuron through the dorsal root of the spinal nerve.

1.1.9 A person produces a smaller volume of urine most probably because ...

- A ADH levels are high in the blood and the renal tubules are more permeable to water.
- B ADH levels are high in the blood and the renal tubules are less permeable to water.
- C ADH levels are low in the blood and the renal tubules are more permeable to water.
- D ADH levels are low in the blood and the renal tubules are less permeable to water.

(9 x 2)

(18)

1.2 Give the correct **biological term** for each of the following descriptions. Write only the term next to the question number (1.2.1 to 1.2.8) in the ANSWER BOOK.

- 1.2.1 The release of an ovum from the ovary
- 1.2.2 The microscopic gap between two consecutive neurons
- 1.2.3 The period of development of the foetus in the uterus
- 1.2.4 The growth movement of a plant in response to a stimulus
- 1.2.5 The type of development in birds where the young are able to independently move and feed themselves after hatching
- 1.2.6 The extra-embryonic membrane that is responsible for the excretion of waste in an amniotic egg
- 1.2.7 Tubules in the testes where spermatogenesis occurs
- 1.2.8 The plant hormone that brings about seed dormancy when conditions are unfavourable (8 x 1) **(8)**

1.3 Indicate whether each of the descriptions in COLUMN I apply to **A ONLY**, **B ONLY**, **BOTH A AND B** or **NONE** of the items in COLUMN II. Write **A only**, **B only**, **both A and B** or **none** next to the question number (1.3.1 to 1.3.3) in the ANSWER BOOK.

COLUMN I		COLUMN II	
1.3.1	An exocrine gland	A:	Cowper's gland
		B:	Pancreas
1.3.2	A component of the peripheral nervous system	A:	Cranial nerves
		B:	Spinal cord
1.3.3	A disorder of the nervous system characterised by the degeneration of the brain cells	A:	Goitre
		B:	Alzheimer's disease

(3 x 2) **(6)**

1.4 The diagram below shows the parts of the male reproductive system.

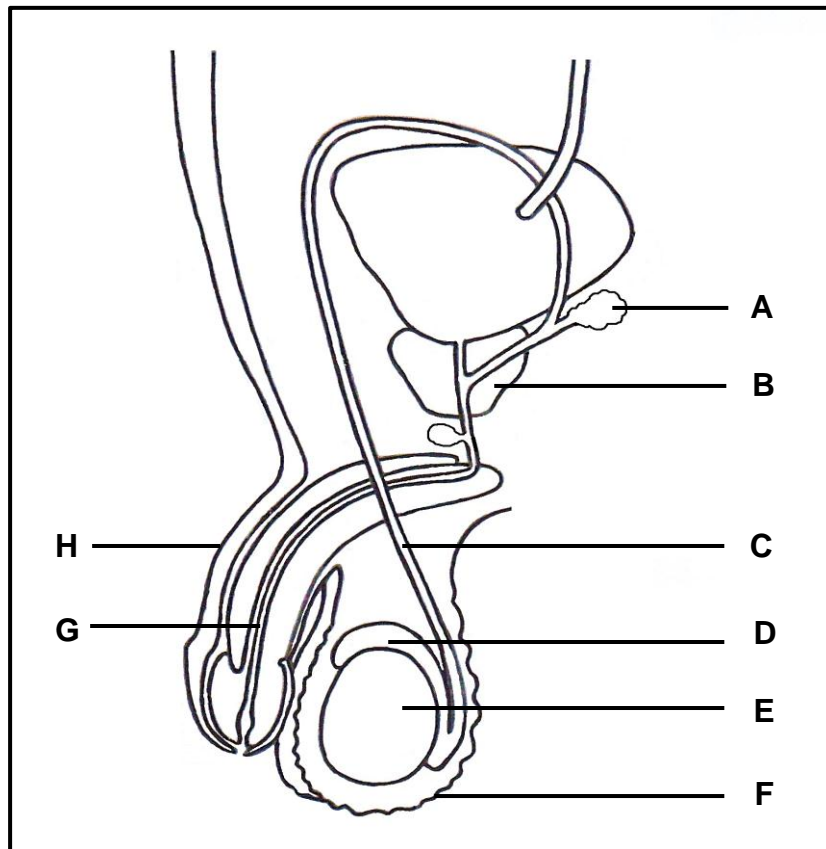

1.4.1 Identify part:

- (a) **C** (1)
- (b) **F** (1)
- (c) **H** (1)

1.4.2 Give the LETTER and NAME of the part that:

- (a) Stores sperm temporarily (2)
- (b) Transports both semen and urine (2)
- (c) Produces testosterone (2)

1.4.3 Give the LETTERS of TWO parts that contribute to the formation of semen.

(2)
(11)

1.5 The diagram below represents an ovum and a sperm.

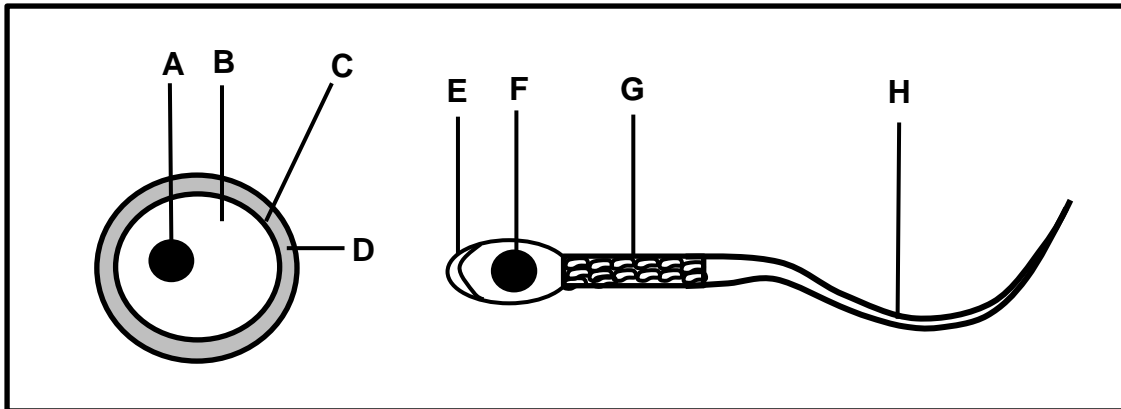

1.5.1 Identify part:

- (a) **B** (1)
- (b) **D** (1)
- (c) **H** (1)

1.5.2 Name the organelle found in large numbers in part **G**. (1)

1.5.3 Give the LETTERS of the TWO parts that fuse during fertilisation. (2)

1.5.4 Name the meiotic process whereby ova are produced. (1)

(7)

TOTAL SECTION A: 50

SECTION B**QUESTION 2**

2.1 The diagram below represents a type of neuron found in the human body.

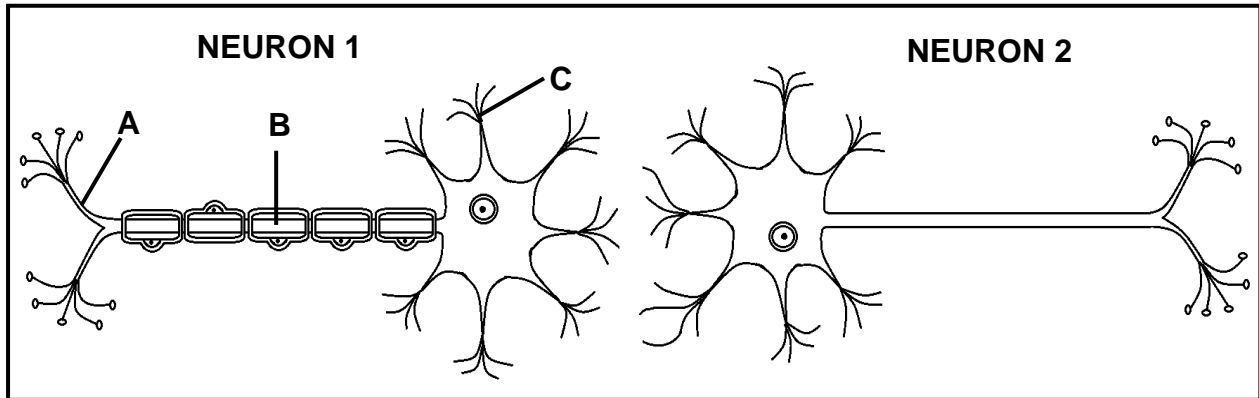

- 2.1.1 Identify the type of neuron shown. (1)
- 2.1.2 Using the LETTERS **A**, **B** and **C** only, give the correct sequence for the transmission of an impulse along neuron 1. (2)
- 2.1.3 Explain how the speed of transmission of impulses will differ for neuron 1 and neuron 2. (3)
- 2.1.4 Explain why a person will feel the stimulus but will not be able to respond if only this type of neuron is damaged. (3)
- (9)**

2.2 The diagram below represents the structure of the human eye.

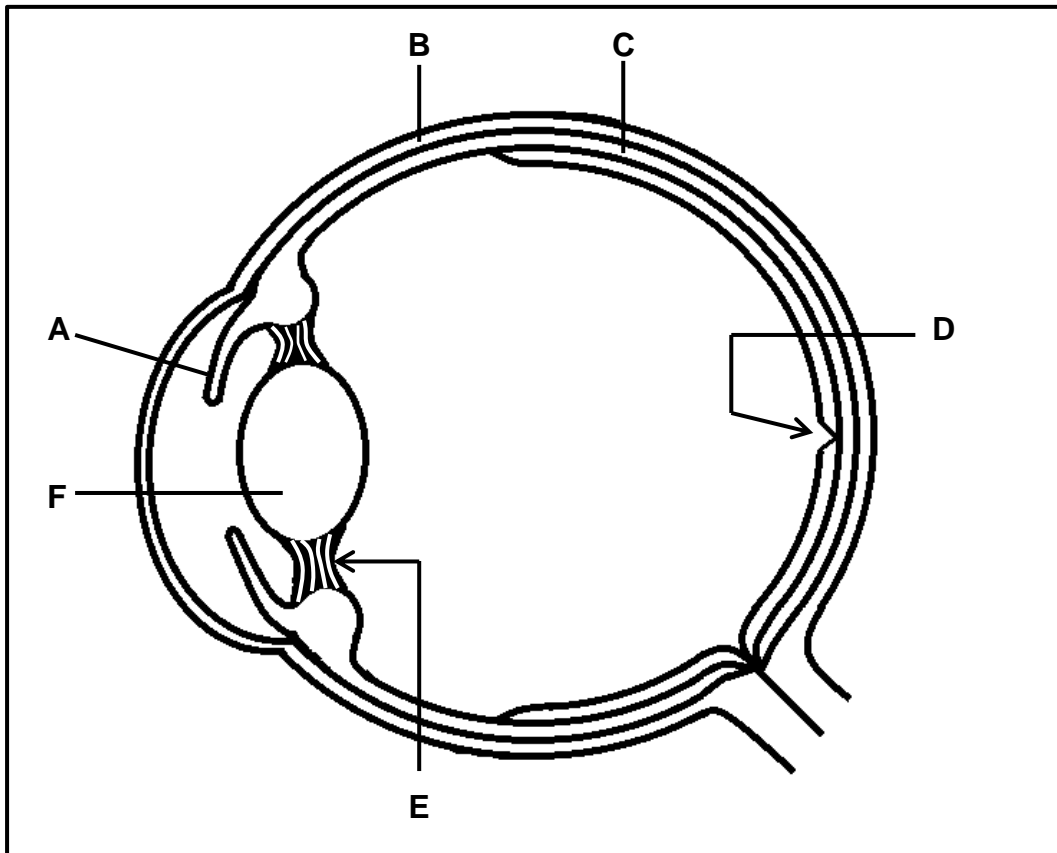

- 2.2.1 Identify part **C**. (1)
- 2.2.2 Give ONE function of part **E**. (1)
- 2.2.3 State why the clearest image will form when light rays fall on part **D**. (1)
- 2.2.4 Explain ONE way in which part **B** is structurally different from part **F**. (4)
- 2.2.5 Describe how the muscles in part **A** function to increase the amount of light entering the eye. (3)
- 2.2.6 Describe how a blurred image forms if a person with normal vision wears spectacles with biconvex lenses while reading a book. (3)
- (13)**

2.3 Read the extract below.

Endometriosis is a medical condition that occurs when the endometrium develops in or on other structures such as the Fallopian tubes, ovaries or pelvis. It is caused by higher than normal levels of oestrogen. Females with this condition will most likely experience mild to severe menstrual pains. This condition can sometimes lead to infertility.

Doctors may prescribe a contraceptive pill as treatment to reduce the development of the endometrium. The pill contains progesterone.

2.3.1 Name the structure where the endometrium normally develops. (1)

2.3.2 Explain why endometriosis in the Fallopian tubes may lead to infertility. (3)

2.3.3 Use the negative feedback mechanism to explain why the pills containing progesterone are successful in treating endometriosis. (4)
(8)

2.4 Describe the process of hearing. **(7)**

2.5 The diagram below shows a developing human foetus.

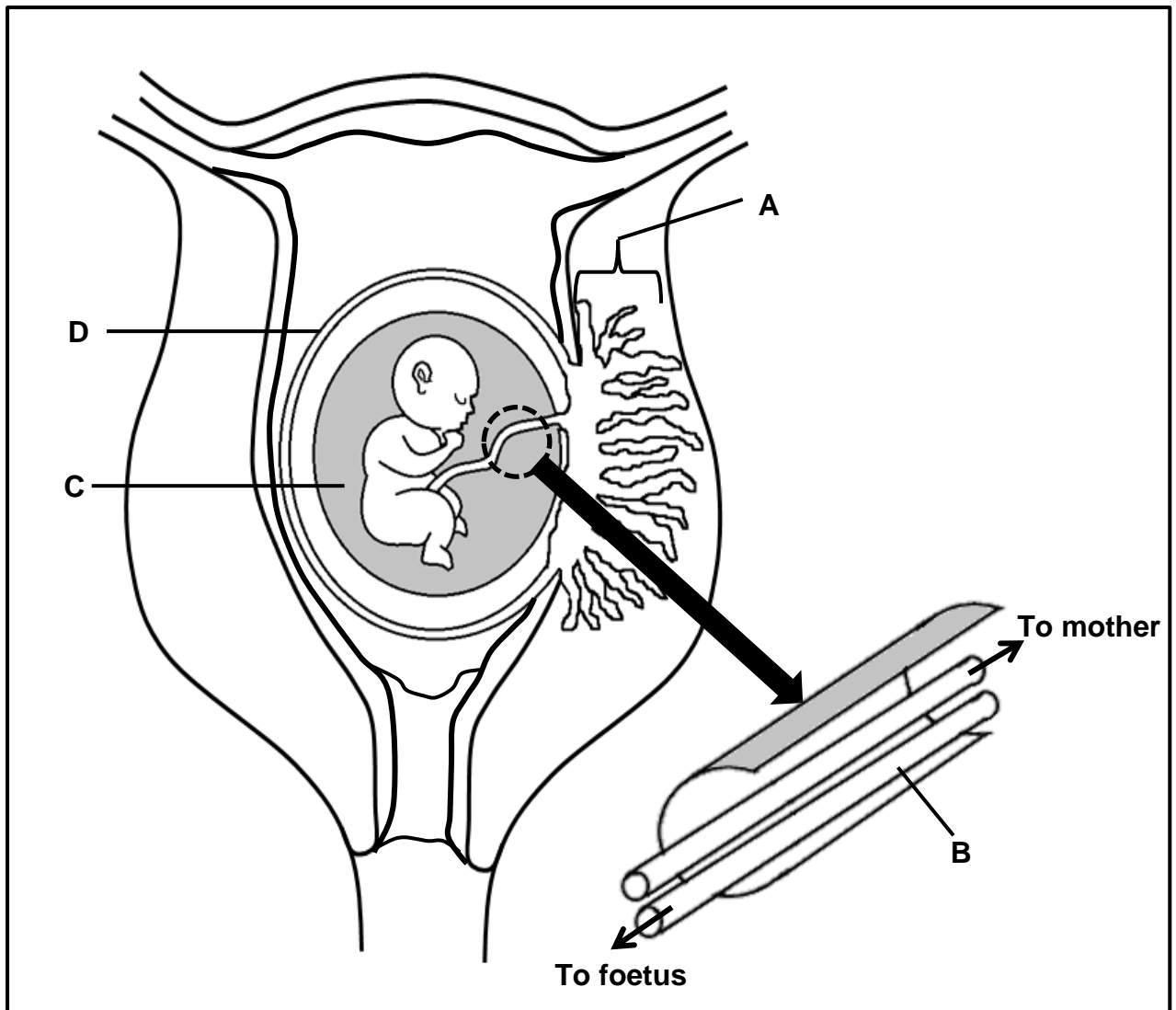

- 2.5.1 Identify part **D**. (1)
- 2.5.2 State TWO functions of the fluid in part **C**. (2)
- 2.5.3 Describe the development of the zygote until implantation occurs. (4)
- 2.5.4 State TWO ways in which part **A** functions in protecting the developing foetus. (2)
- 2.5.5 Identify blood vessel **B**. (1)
- 2.5.6 Describe how the nutrition of a human foetus differs from that of oviparous organisms. (3)

(13)
[50]

QUESTION 3

3.1 The diagrams below show the human brain and human kidney.

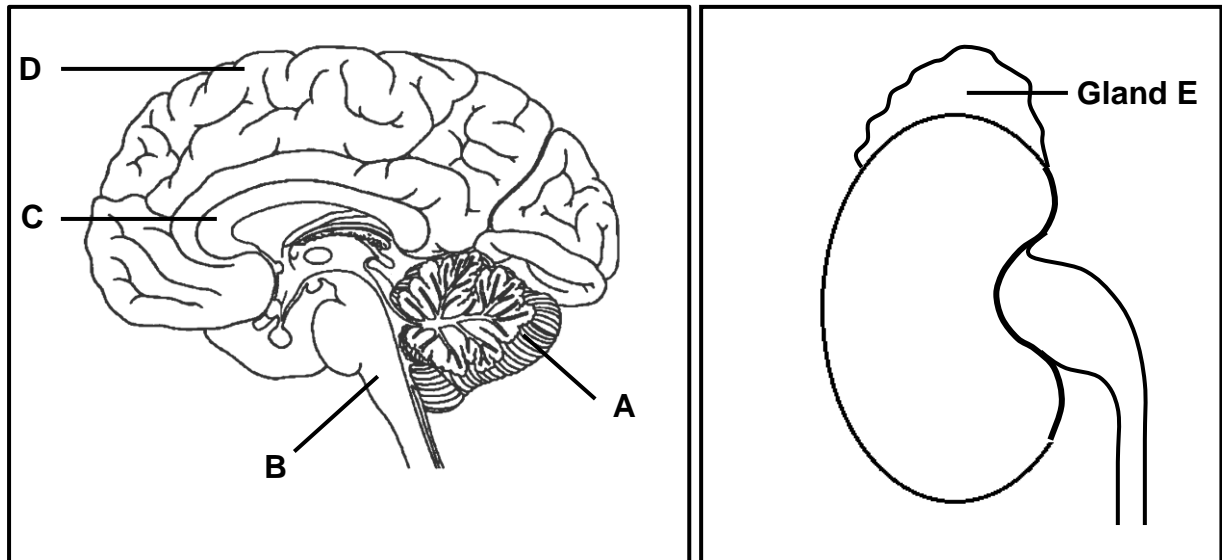

- 3.1.1 Identify part **A**. (1)
- 3.1.2 State ONE function of part **C**. (1)
- 3.1.3 A person sustained a head injury in a car accident and lost his memory.
Write down the LETTER and NAME of the part of the brain that was affected. (2)
- 3.1.4 During an emergency situation, gland **E** releases a hormone that prepares the body for a 'fight or flight' response by stimulating an increase in breathing rate and heart rate. This increase leads to increased energy production in the skeletal muscles and an increase in blood carbon dioxide levels.
- (a) Name the hormone secreted by gland **E** in an emergency situation. (1)
- (b) Explain how an increase in breathing rate and heart rate results in increased energy production in skeletal muscles. (4)
- (c) Describe how part **B** is involved in carbon dioxide homeostasis. (4)
- (13)**

- 3.2 The table below shows the average rate of blood flow to the skin at different environmental temperatures.

ENVIRONMENTAL TEMPERATURE (°C)	AVERAGE RATE OF BLOOD FLOW TO THE SKIN (mℓ /100 mℓ tissue/min)
0	2,5
5	4
20	4,5
35	11
45	18
50	19

- 3.2.1 Give the environmental temperature at which there was the greatest average rate of blood flow to the skin. (1)
- 3.2.2 Describe the relationship between the environmental temperature and the average rate of blood flow to the skin. (2)
- 3.2.3 Calculate the percentage increase in blood flow to the skin between 5 °C and 35 °C. Show ALL your workings. (3)
- 3.2.4 Explain the average rate of blood flow to the skin between 20 °C and 45 °C. (4)
- 3.2.5 Frostbite is a condition where long term exposure to extremely cold conditions (0 °C or less) leads to the death of tissue in areas like the hands and feet.
- Use the data from the table to explain why tissue may die. (2)
- (12)**
- 3.3 3.3.1 Describe the negative feedback mechanism that occurs when thyroxin levels in the blood are high. (5)
- 3.3.2 A person has a medical condition that results in the under-secretion of thyroxin.
- Explain why this person will gain weight if the thyroxin levels remain continuously low in the blood. (3)
- (8)**

3.4 A group of learners conducted an investigation to determine the effect of auxins on the growth of stems in bean seedlings.

The procedure was as follows:

- 30 bean seeds were allowed to germinate for 5 days to produce seedlings.
- The seedlings were divided into 3 groups (**A**, **B** and **C**) of 10 seedlings each.
- The tips of all the seedlings were cut at the same length.
- In group **A**, the cut tip was placed back on top of the young stem.
- In group **B**, the tip was not placed back.
- In group **C**, a piece of plastic was placed on top of the cut surface and the tip was then placed on top of the plastic.
- The seedlings in all the groups were placed in a dark cupboard for a week.
- The growth of the stem was then observed.

The diagram below shows how the seedlings in each group were treated.

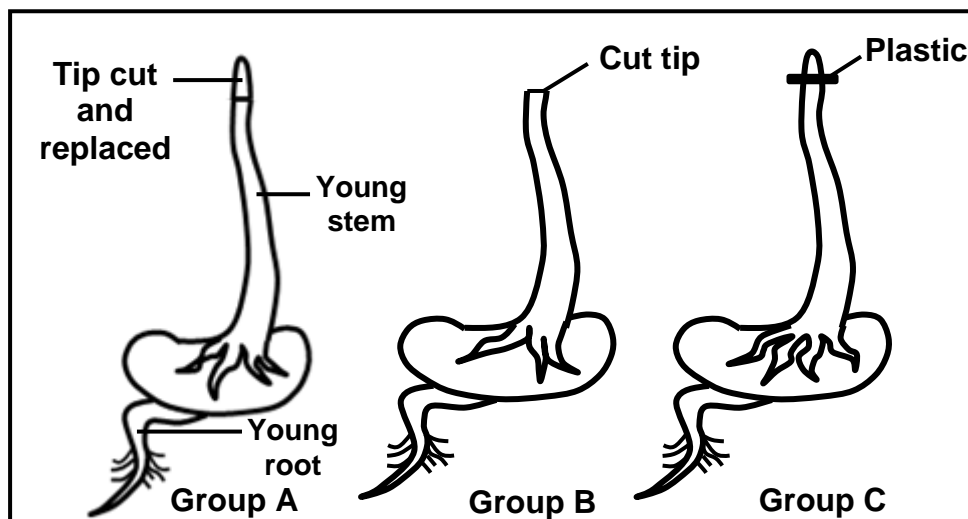

- 3.4.1 Identify the dependent variable in this investigation. (1)
- 3.4.2 Why did the learners cut the tips of the young stems? (1)
- 3.4.3 Give ONE reason why 10 bean seedlings were used in each group. (1)
- 3.4.4 Write down the LETTER(S) (**A**, **B** or **C**) of the group(s) where there will be no upward growth of the stem. (2)
- 3.4.5 Describe how auxins cause apical dominance. (3)
- 3.4.6 Name the plant hormone:
- (a) Other than auxins, that promotes the germination of seeds (1)
- (b) That inhibits the germination of seeds (1)

(10)

3.5 Read the extract below.

The bluefin tuna, the great white shark and the bottlenose dolphin are three aquatic species that are found in the Indian Ocean.

An adult bluefin tuna releases up to 540 000 000 eggs into the water annually, while the great white shark female produces 2 to 12 offspring through ovovivipary every two years. A bottlenose dolphin female, being a mammal, is viviparous and produces one offspring every two to three years.

- 3.5.1 Name the type of fertilisation that takes place in the bottlenose dolphin. (1)
- 3.5.2 Explain how TWO of the reproductive strategies of the great white shark increase its reproductive success. (4)
- 3.5.3 Explain ONE reason why the bluefin tuna releases a large number of eggs. (2)
- (7)**
[50]
- TOTAL SECTION B: 100**
GRAND TOTAL: 150